

PCM-9575

**EBX VIA Eden/Ezra SBC with
CPU, LCD, Ethernet, Audio, PCI
and PC/104-Plus**

Users Manual

Copyright

This document is copyrighted, © 2002. All rights are reserved. The original manufacturer reserves the right to make improvements to the products described in this manual at any time without notice.

No part of this manual may be reproduced, copied, translated or transmitted in any form or by any means without the prior written permission of the original manufacturer. Information provided in this manual is intended to be accurate and reliable. However, the original manufacturer assumes no responsibility for its use, nor for any infringements upon the rights of third parties that may result from such use.

Acknowledgements

Award is a trademark of Award Software International, Inc.

VIA is a trademark of VIA Technologies, Inc.

IBM, PC/AT, PS/2 and VGA are trademarks of International Business Machines Corporation.

Intel and Pentium are trademarks of Intel Corporation.

Microsoft Windows® is a registered trademark of Microsoft Corp.

RTL is a trademark of Realtek Semi-Conductor Co., Ltd.

ESS is a trademark of ESS Technology, Inc.

UMC is a trademark of United Microelectronics Corporation.

SMI is a trademark of Silicon Motion, Inc.

Creative is a trademark of Creative Technology LTD.

All other product names or trademarks are properties of their respective owners.

This manual is for the PCM-9575.

1st Edition, Printed in Taiwan May, 2002

Packing List

Before you begin installing your card, please make sure that the following materials have been shipped:

- 1 PCM-9575 all-in-one single board computer
- 1 CD disk for utility and drivers
- 1 startup manual
- 1 Power cable (p/n: 1703080101)
- 1 Mini Jumper*10 PCS Package (p/n: 9689000002)

If any of these items are missing or damaged, contact your distributor or sales representative immediately.

Model No. List

Description

PCM-9575F-J0A1

W/ Eden-400 CPU and heat sink

PCM-9575F-Q0A1

W/ Ezra-800 CPU and heat sink W/ FAN

PCM-9575F-M0A1

W/ Eden-667 CPU and heat sink

Contents

Chapter 1	General Information	1
1.1	Introduction	2
1.2	Features	3
1.3	Specifications	4
1.3.1	Standard EBX SBC Functions	4
1.3.2	VGA/LCD Interface	4
1.3.3	LVDS: Supports 2 Channel (2 x 18 bit) LVDS interface.....	5
1.3.4	Audio function.....	5
1.3.5	TV-out (optional)	5
1.3.6	PCI bus Ethernet interface.....	5
1.3.7	Mechanical and Environmental.....	5
1.4	Board layout: dimensions.....	6
	Figure 1.1: Board layout: dimensions	6
Chapter 2	Installation	7
2.1	Jumpers.....	8
	Table 2.1: Jumpers	8
2.2	Connectors.....	8
	Table 2.2: Connectors	8
2.3	Locating jumpers.....	10
	Figure 2.1: Jumper locations	10
2.4	Locating Connectors	11
	Figure 2.2: Connectors (component side)	11
2.5	Setting Jumpers	12
2.6	Clear CMOS (JP4)	13
	Table 2.3: CMOS clear (JP4).....	13
2.7	Installing DIMMs.....	14
2.8	IDE, CDROM hard drive connector (CN14, CN16).....	14
2.8.1	Connecting the hard drive	14
2.9	Solid State Disk.....	15
2.9.1	CompactFlash (CN26).....	15
2.10	Floppy drive connector (CN18)	15
2.10.1	Connecting the floppy drive	15
2.11	Parallel port connector (CN15)	16
2.12	Keyboard and PS/2 mouse connector (CN25)	16
2.13	Power & HDD LED, Reset Switch (CN13, CN22)	16
2.13.1	Power & HDD LED (CN13).....	17
2.13.2	Reset switch (CN22)	17
2.14	Power connectors (CN27, CN5, FAN1).....	17
2.14.1	Peripheral power connector, -5 V, -12 V (CN27).....	17

2.14.2	Main power connector, +5 V, +12 V (CN5)	17
2.14.3	CPU Fan power supply connector (FAN1)	17
2.15	ATX power control connector (CN3, CN23)	17
2.15.1	ATX feature (CN3), soft power switch conn (CN23)	17
	Figure 2.3: Wiring for ATX soft power switch function	18
2.16	IR connector (CN24)	18
2.17	Audio interfaces (CN4, CN2)	18
2.17.1	Audio connector (CN4)	19
2.17.2	CD audio input connector (CN2)	19
2.18	COM port connector (CN19)	19
2.18.1	COM2 RS-232/422/485 setting (JP6)	19
2.19	VGA/LCD/LVDS interface connections	20
2.19.1	CRT display connector (CN8)	20
2.19.2	Flat panel display connector (CN11)	20
2.19.3	Extension flat panel connector (CN10)	20
2.19.4	LVDS LCD panel connector (CN9)	20
2.19.5	Panel type selection (S1)	20
	Table 2.4: S1 Panel Type select	21
2.20	TV-out interface (optional) (CN1)	21
2.21	Ethernet configuration	22
2.21.1	100Base-T connector (CN12)	22
2.21.2	Network boot	22
2.21.3	LAN controller power select (JP2)	22
	Table 2.5: LAN controller power select (JP2)	22
2.22	Watchdog timer configuration	22
2.22.1	Watchdog timer action (JP5)	23
	Table 2.6: Watchdog timer action (JP5)	23
2.23	USB connectors (CN20, CN28)	23
Chapter 3	Software Configuration	25
3.1	Introduction	26
3.2	Connections to Three Standard LCDs	27
3.2.1	Connections (640 x 480 TFT color LCD)	27
	Table 3.1: Connections to Toshiba LTM10C209A	27
3.2.2	Connections (1024 x 768 TFT color LCD)	28
	Table 3.2: Connections to Toshiba LTM15C151A	28
3.2.3	Connections (800 x 600 TFT color LCD)	29
	Table 3.3: Connections to Toshiba LTM12C275A	29
3.3	Ethernet software configuration	30

Chapter 4	Award BIOS Setup.....	33
4.1	System test and initialization.....	34
4.1.1	System configuration verification	34
4.2	Award BIOS setup	35
4.2.1	Entering setup.....	35
	Figure 4.1: BIOS setup program initial screen.....	35
4.2.2	Standard CMOS Features setup	36
	Figure 4.2: CMOS Features setup	36
4.2.3	Advanced BIOS Features setup.....	37
	Figure 4.3: Advanced BIOS Features setup	37
4.2.4	Advanced Chipset Features setup.....	38
	Figure 4.4: Advanced Chipset Features setup	38
4.2.5	Integrated Peripherals.....	39
	Figure 4.5: Integrated Peripherals	39
4.2.6	Power Management Setup.....	39
	Figure 4.6: Power Management Setup	39
4.2.7	PnP/PCI Configurations	40
	Figure 4.7: PnP/PCI Configurations	40
4.2.8	PC Health Status.....	40
	Figure 4.8: PC Health Status.....	40
4.2.9	Frequency/Voltage Control	41
	Figure 4.9: Frequency/Voltage Control	41
4.2.10	Load Optimized Defaults	42
	Figure 4.10: Load BIOS defaults screen	42
4.2.11	Set Password.....	42
4.2.12	Save & Exit Setup	43
4.2.13	Exit Without Saving	44
Chapter 5	PCI SVGA Setup	45
5.1	Introduction	46
5.1.1	Chipset.....	46
5.1.2	Display memory	46
5.1.3	Display types	46
5.1.4	Dual/Simultaneous Display.....	47
	Figure 5.1: Selecting Display Settings	47
5.2	Installation of the SVGA Driver	48
5.2.1	Installation for Windows 95	48
5.2.2	Installation for Windows 98/Me.....	52
5.2.3	Installation for Windows NT.....	57
5.2.4	Installation for Windows 2000	62
5.2.5	Installation for Windows XP.....	67
5.3	Further Information	73

Chapter 6	Audio Setup.....	75
6.1	Introduction	76
6.2	DOS utilities.....	76
6.2.1	VIA Sound Blaster Pro compatible set up program	76
6.2.2	VIA Sound Blaster Installation	77
6.3	Driver installation.....	77
6.3.1	Before you begin	77
6.3.2	Windows 95/98 drivers	78
6.3.3	Windows NT drivers	85
6.3.4	Windows 2000 Drivers.....	88
Chapter 7	PCI Bus Ethernet Interface.....	93
7.1	Introduction	94
7.2	Installation of Ethernet driver	94
7.2.1	Installation for MS-DOS and Windows 3.1	94
7.2.2	Installation for Windows 98	95
7.2.3	Installation for Windows 2000	98
7.2.4	Installation for Windows NT.....	103
7.3	Further information	109
Appendix A	Programming the Watchdog Timer	111
A.1	Supported Input Timing Modes	112
Appendix B	Installing PC/104-Plus Modules.....	115
B.1	Installing PC/104-Plus Modules.....	116
	Figure B.1: PC/104+ module mounting diagram.....	117
	Figure B.2: PC/104+ module dimensions (mm) (± 0.1).....	118
Appendix C	Pin Assignments	119
C.1	CPU Fan Power Connector (FAN 1).....	120
C.2	Ethernet 10/100Base-T Connector (CN12).....	120
C.3	Audio Connector (CN4).....	121
C.4	Audio In Connector (CN2).....	121
C.5	Main Power Connector (CN5)	122
C.6	Keyboard and PS/2 Mouse Connector (CN25).....	123
C.7	Floppy Disk Drive Connector (CN18).....	124
C.8	PC/104 plus Connectors (CN17).....	125
C.9	IDE Hard Drive Connector (CN14, CN16)	127
C.10	Parallel Port Connector (CN15)	128
C.11	Power & HDD LED Connector(CN13)	129
C.12	Reset Button Connector (CN22)	129
C.13	USB Connector (CN20, CN28).....	130
C.14	LCD Inverter Backlight Connector (CN6).....	130
C.15	IR Connector (CN24).....	131
C.16	CRT Display Connector (CN8).....	131

Table of Contents

C.17	TV (video) Out Connector (CN1)	132
C.18	Flat Panel Connector (CN11)	133
C.19	Extended Flat Panel Display Connector (CN10)	134
C.20	LCD Signal Mapping	135
C.21	LVDS Connector (CN9).....	136
C.22	Peripheral Power Connector (CN27)	136
C.23	COM Port Connector (CN19)	137
C.24	CompactFlash Card Connector (CN26)	138
C.25	ATX Power Feature Connector (CN3).....	139
Appendix D	System Assignments	141
D.1	System I/O Ports.....	142
D.2	1st MB memory map.....	143
D.3	DMA channel assignments.....	143
D.4	Interrupt assignments	144
Appendix E	Optional Extras for the PCM-9575	145
E.1	PCM-10586-5A00 cable kit for PCM-9575.....	146
E.2	Optional LCD cables 10.4" TFT LCD panel (CN14) ...	147
E.3	Optional USB cable (CN20)	147
E.4	ATX Power Control Cable (CN3).....	147
E.5	Optional PC/104+ to PCI Module.....	147
E.6	Optional 24 bit LCD cable adaptor	147
Appendix F	Mechanical Drawings.....	149
F.1	Mechanical Drawings.....	150
	Figure F.1: PCM-9575 Mechanical Drawing	150
	Figure F.2: PCM-9575 Mech Drawing (component side).	151
	Figure F.3: PCM-9575 Mech Drawing (solder side).....	152

General Information

This chapter gives background information on the PCM-9575.

Sections include:

- Introduction
- Features
- Specifications
- Board layout and dimensions

Chapter 1 Introduction

1.1 Introduction

The PCM-9575 is a VIA low-power Eden/Ezra processor single board computer (SBC) with audio controller, a 4X AGP SVGA controller, a PCI 10/100Base-T Ethernet interface, one PCI slot, and one PC/104-Plus expansion connector. The PCM-9575's design is based on the EBX form factor that provides support for PC/104 and PC/104-Plus module expansion. The EBX form factor also provides a convenient connector layout for easy assembly, more efficient cable connections and better overall embedded system integration. When using an Intel® Pentium® III processor, the PCM-9575 achieves outstanding performance that surpasses most SBCs in its class. This compact (only 5.75" x 8") unit offers all the functions of a single board industrial computer, but still fits in the space of a 5.25" floppy drive.

On-board features include, four serial ports (three RS-232, one RS-232/422/485), one multi-mode parallel (ECP/EPP/SPP) port, two USB (Universal Serial Bus) ports, a floppy drive controller, and a keyboard/PS/2 mouse interface. The built-in high-speed PCI IDE controller supports both PIO and UDMA/100 bus master modes. Up to four IDE devices can be connected, including large hard disks, CD-ROM drives, and tape backup drives.

The PCM-9575 features power management to minimize power consumption. It complies with the "Green Function" standard and supports Doze, Standby and Suspend modes. In addition, the board's watchdog timer can automatically reset the system or generate an interrupt if the system stops due to a program bug or EMI.

Highly integrated multimedia SBC

The PCM-9575 is a highly integrated multimedia SBC that combines audio, video, and network functions on a single computer board the size of a 5.25" floppy drive. It provides 16-bit half-duplex, 8-bit full-duplex, integrated 3D audio, and up to 1024 x 768 resolution @ 16.8 M colors with 8/16/32MB system memory. Major on-board devices adopt PCI technology, to achieve outstanding computing performance when used with Intel® Pentium® processors. The PCM-9575 also supports TV-out that supports NTSC/PAL format for multimedia applications.

1.2 Features

- Embedded VIA low-power Eden/Ezra processor
- EBX form factor which supports both PC/104-*Plus* and PCI slot
- Supports one 36 bit TFT LCD panel, with up to 1024 x 768 resolution
- Supports 2 channel LVDS interface
- 100/10Base-T Ethernet interface, IEEE 802.3U compatible
- Supports wake-on-Lan with ATX power supply
- TV-out function supports NTSC and PAL formats
- 4 serial ports (three RS-232 and one RS-232/422/485)
- USB interface complies with USB Rev. 1.10
- 62-level Watchdog timer by system reset or IRQ
- 2 IDE channels for HDD and CD-ROM

1.3 Specifications

1.3.1 Standard EBX SBC Functions

- **CPU:** Onboard VIA Ezra 800MHz (PCM-9575F-Q0A1) or VIA Eden 400 MHz (PCM-9575F-J0A1) or VIA Eden 667Mhz processor (PCM-9575F-M0A1)
- **BIOS:** Award 256 KB Flash memory
- **System memory:** One DIMM socket accepts 64 MB up to 512 MB SDRAM
- **System Chipset:** VIA PL133 chipset , VT8606T (TwisterT) & VT82C686B
- **Cache memory:** 128KB L1 and 64 KB L2 cache memory on the processor

- **Enhanced IDE interface:** Two channels supports up to four EIDE devices. BIOS auto-detect, PIO Mode 3 or Mode 4, UDMA 33 transfer. Primary IDE support up to UDMA 66/100 mode
- **FDD interface:** Supports up to two FDDs
- **Serial ports:** Four serial RS-232 ports, COM1, 3, 4: RS-232, COM2: RS-232/422/485
- **Parallel port:** One parallel port, supports SPP/EPP/ECP mode
- **Infrared port:** Shared with COM2. Transfer rates up to 115Kbps
- **Keyboard/mouse connector:** Supports standard PC/AT keyboard and a PS/2 mouse
- **Power management:** Supports power saving modes including Normal/Standby/Suspend modes. APM 1.2 compliant
- **Watchdog timer:** 62 level timer intervals
- **USB:** Two universal serial bus ports (4 USB port option)
- **Expansion:** One PCI slot and PC/104 plus connector for ISA and PCI control board
- **Solid State Disk**
Supports one 50-pin socket for CFC type I/II
Supports M-Systems DOC[®] 2000

1.3.2 VGA/LCD Interface

- **Chipset:** VIA Twister chip with integrated Savage4 2D/3D/Video Accelerator
- **Frame buffer:** Supports 8/16/32 MB frame buffer with system memory
- **Interface:** 4X AGP VGA/LCD interface, Support for 9, 12, 15, 18, 24, 36 bit TFT and optional 16- or 24-bit DSTN panel
- **Display mode:** CRT Modes: 1280 x 1024@32bpp (60Hz), 1024 x 768 @ 32bpp (85 Hz); LCD/Simultaneous Modes: 1280 x 1024 @16bpp (60 Hz), 1024 x 768 @16bpp (60Hz)

1.3.3 LVDS: Supports 2 Channel (2 x 18 bit) LVDS interface

- **Chipset:** VIA VT8606T (TwisterT)

1.3.4 Audio function

- **Chipset:** VIA 82C686 South Bridge
- **Audio controller:** AC97 Ver. 2.0 compliant interface, Multistream Direct sound and Direct Sound 3D acceleration
- **Stereo sound:** 8-bit full-duplex
- **Audio interface:** Microphone in, Line in, CD audio in; Line out, Speaker L, Speaker R
- **Power:** Accepts +12 V source for improved audio quality

1.3.5 TV-out (optional)

- **Chipset:** VIA VT 1621
Supports NTSC, NTSC=EIA (Japan) and PAL TV formats

Provides Composite video and S-video outputs via RCA (composite) connector and S-video connector
Supports 640 x 480 and 800 x 600 input resolutions
Supports Windows® 95/98/NT and Windows XP drivers
Over-scan, under-scan and position adjustable
Auto-detection of TV presence met Interface

1.3.6 PCI bus Ethernet interface

- **Chipset:** REALTEK RTL8139 (Option Intel 82559) Ethernet controller
- **Ethernet interface:** IEEE 802.3U compatible 100/10Base-T interface.
Includes software drivers and boot ROM
- **Wake-on-LAN:** Supports wake-on-LAN function with ATX power control

1.3.7 Mechanical and Environmental

- **Dimensions (L x W):** EBX form factor, 203 x 146 mm (8" x 5.75")
- **Power supply voltage:** +5 V $\pm 5\%$, +12V $\pm 5\%$ (PCM-9575 rev A101, A102)
+5 V $\pm 5\%$ (PCM-9575 rev A103)
- **Power requirements:**
 - Max:**
 - 4.5A @ +5V, 0.55A @ +12V (within 5ms after power on) (rev A101, A102)
 - 4.5A @ +5V (rev A103 or higher)
 - Typical:**
 - 3.3 A @ +5V, 0.08A @ +12V (with 256 MB DRAM, Ezra 800 MHz CPU)(rev A101, A102)
 - 2.78A @ +5V, 0.08A @ +12V (with 256 MB DRAM, Eden 400 MHz CPU)(rev A101, A102)
 - 3.4 A @ +5V (with 256MB DRAM, Ezra 800 MHz CPU) (rev A103 or higher)
 - 2.88A @ +5V (with 256MB DRAM, Eden 400 MHz CPU) (rev A103 or higher)
- **Operating temperature:** 0 ~ 60°C (32 ~ 140°F)
- **Operating humidity:** 0% ~ 90% Relative Humidity, Noncondensing
- **Weight:** 0.64 kg (weight of total package)

1.4 Board layout: dimensions

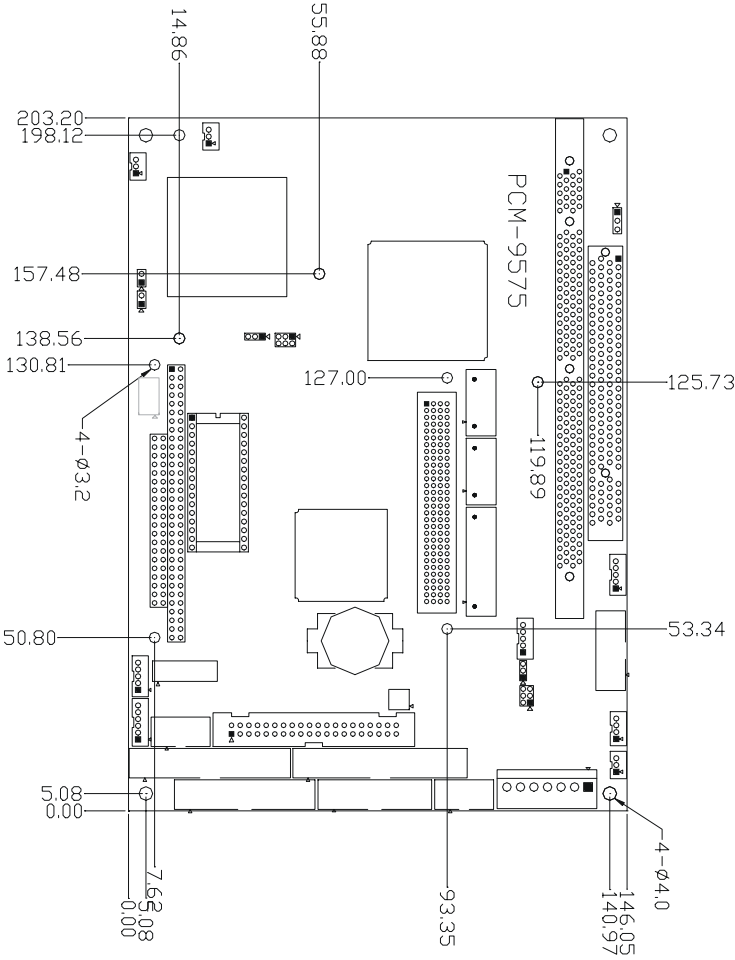

Figure 1.1: Board layout: dimensions

CHAPTER 2

Installation

This chapter explains the setup procedures of PCM-9575 hardware, including instructions on setting jumpers and connecting peripherals, switches and indicators. Be sure to read all safety precautions before you begin the installation procedure.

Chapter 2 Installation

2.1 Jumpers

The PCM-9575 has a number of jumpers that allow you to configure your system to suit your application. The table below lists the functions of the various jumpers.

Table 2.1: Jumpers

Label	Function
JP1	PCI VIO select
JP2	LAN controller power select (Rev A101only)
JP3	DOC2000 address select
JP4	CMOS clear
JP5	Watchdog timer action
JP6	COM2 RS232/422/485 setting
S1	Panel type select

2.2 Connectors

On-board connectors link the PCM-9575 to external devices such as hard disk drives, a keyboard, or floppy drives. The table below lists the function of each of the board's connectors.

Table 2.2: Connectors

Label	Function
CN1	TV-out connector
CN2	Audio CD in connector
CN3	ATX feature connector
CN4	Audio connector
CN5	EBX Main Power connector
CN6	Backlight control connector

Table 2.2: Connectors

CN8	CRT display connector
CN9	LVDS connector
CN10	Ext. flat panel connector
CN11	Flat panel connector
CN12	Ethernet connector
CN13	Power & HDD LED connector
CN14	IDE hard drive connector (secondary)
CN15	Parallel port connector
CN16	IDE hard drive connector (primary)
CN17	PC/104 plus (ISA + PCI) expansion
CN18	Floppy drive connector
CN19	COM port connector
CN20	USB channel 1, 2 connector
CN21	N/A
CN22	reset button connector
CN23	ATX power on/off switch connector
CN24	IR connector
CN25	Keyboard and PS/2 mouse connector
CN26	CFC connector
CN27	Peripheral power connector
CN28	USB channel 3, 4 connector (optional)
Fan1	CPU fan power connector

2.3 Locating jumpers

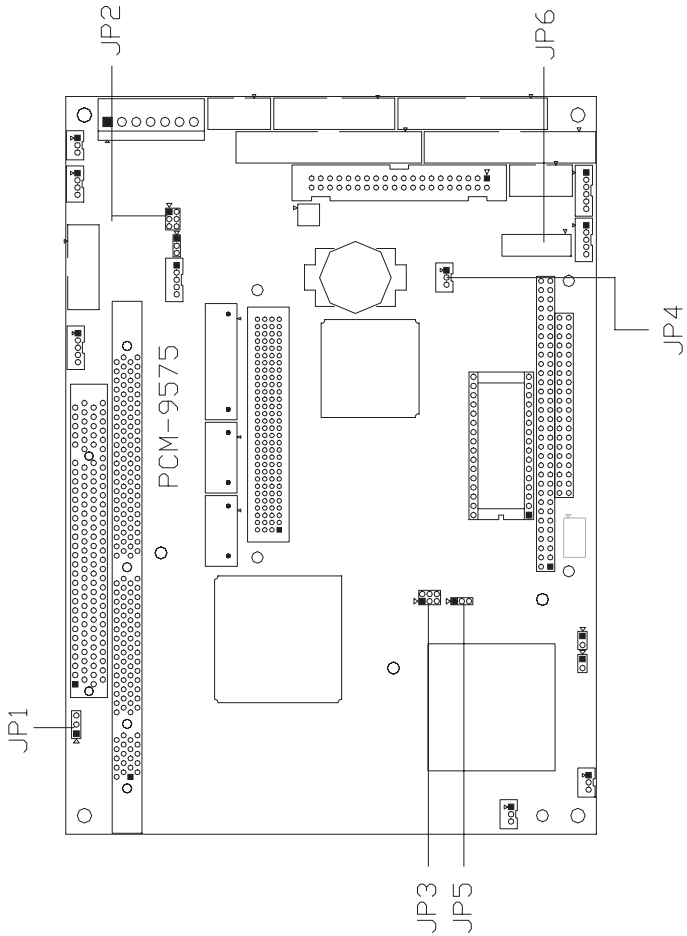

Figure 2.1: Jumper locations

2.4 Locating Connectors

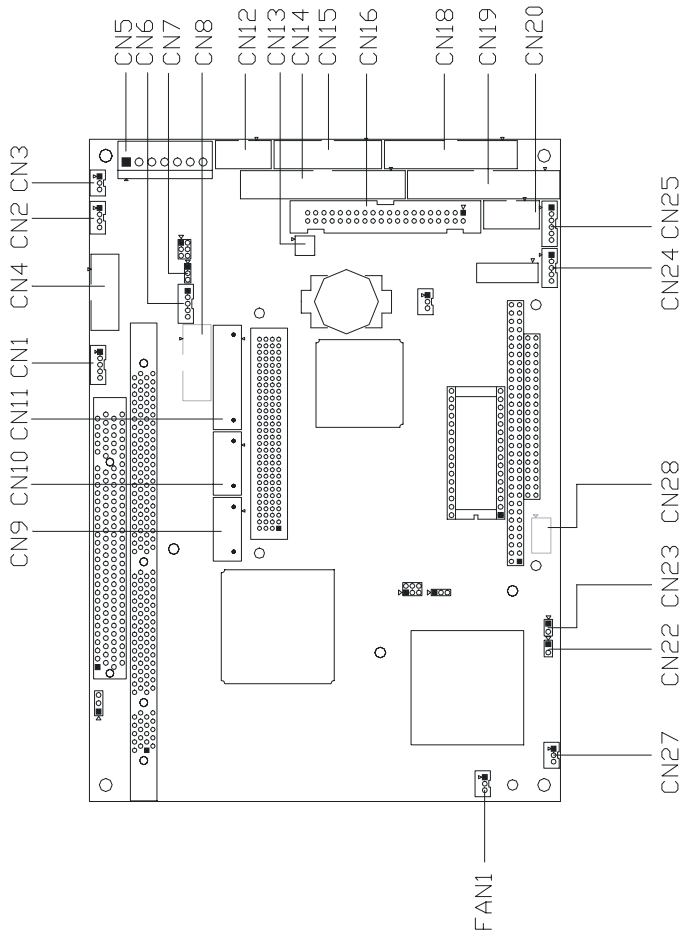
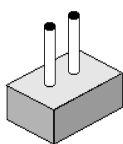

Figure 2.2: Connectors (component side)

2.5 Setting Jumpers

You may configure your card to match the needs of your application by setting jumpers. A jumper is a metal bridge used to close an electric circuit. It consists of two metal pins and a small metal clip (often protected by a plastic cover) that slides over the pins to connect them. To “close” a jumper, you connect the pins with the clip. To “open” a jumper, you remove the clip. Sometimes a jumper will have three pins, labeled 1, 2 and 3. In this case you would connect either pins 1 and 2, or 2 and 3.



open

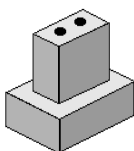

closed

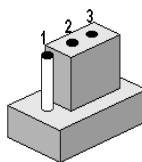

closed 2-3

The jumper settings are schematically depicted in this manual as follows:

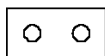

open



closed

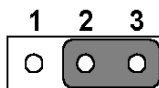

closed 2-3

A pair of needle-nose pliers may be helpful when working with jumpers.

If you have any doubts about the best hardware configuration for your application, contact your local distributor or sales representative before you make any changes.

Generally, you simply need a standard cable to make most connections.

2.6 Clear CMOS (JP4)

Warning! To avoid damaging the computer, always turn off the power supply before setting “Clear CMOS.” Before turning on the power supply, set the jumper back to “3.0 V Battery On.”

This jumper is used to erase CMOS data and reset system BIOS information.

The procedure for clearing CMOS is:

1. Turn off the system.
2. Short pin 2 and pin 3.
3. Return jumper to pins 1 and 2.
4. Turn on the system. The BIOS is now reset to its default setting

Table 2.3: CMOS clear (JP4)

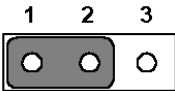
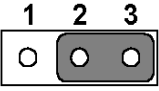
*3.0 V Battery on	Clear CMOS
	

* default setting

2.7 Installing DIMMs

The procedure for installing DIMMs is described below. Please follow these steps carefully. The number of pins are different on either side of the breaks, so the module can only fit in one way. DIMM modules have different pin contacts on each side, and therefore have a higher pin density.

1. Make sure that the two handles of the DIMM socket are in the “open” position. i.e. The handles remain leaning outward.
2. Slowly slide the DIMM module along the plastic guides on both ends of the socket.
3. Press the DIMM module right down into the socket, until you hear a click. This is when the two handles have automatically locked the memory module into the correct position of the socket.

To **remove** the memory module, just push both handles outward, and the module will be ejected from the socket.

2.8 IDE, CDROM hard drive connector (CN14, CN16)

The PCM-9575 provides 2 IDE channels which you can attach up to four Enhanced Integrated Device Electronics hard disk drives or CDROM to the PCM-9575's internal controller. The PCM-9575's IDE controller uses a PCI interface. This advanced IDE controller supports faster data transfer, PID mode 3, mode 4 and UDMA/100. The secondary channel supports UDMA/33 only.

2.8.1 Connecting the hard drive

Connecting drives is done in a daisy-chain fashion. It requires one of two cables (not included in this package), depending on the drive size. 1.8" and 2.5" drives need a 1 x 44-pin to 2 x 44-pin flat-cable connector. 3.5" drives use a 1 x 44-pin to 2 x 40-pin connector.

Wire number 1 on the cable is red or blue, and the other wires are gray.

1. Connect one end of the cable to CN14 or CN16. Make sure that the red (or blue) wire corresponds to pin 1 on the connector, which is labeled on the board (on the right side).
2. Plug the other end of the cable into the Enhanced IDE hard drive, with pin 1 on the cable corresponding to pin 1 on the hard drive.

(See your hard drive's documentation for the location of the connector.)

If desired, connect a second drive as described above.

Unlike floppy drives, IDE hard drives can connect to either end of the cable. If you install two drives, you will need to set one as the master and one as the slave by using jumpers on the drives. If you install only one drive, set it as the master.

2.9 Solid State Disk

The PCM-9575 provides a CompactFlash™ card socket and DiskOnChip socket for Solid state disk solutions.

2.9.1 CompactFlash (CN26)

The CompactFlash card shares a secondary IDE channel which can be enabled/disabled via the BIOS settings.

2.10 Floppy drive connector (CN18)

You can attach up to two floppy drives to the PCM-9575's on-board controller. You can use any combination of 5.25" (360 KB and 1.2 MB) and/or 3.5" (720 KB, 1.44 MB, and 2.88 MB) drives.

A 34-pin daisy-chain drive connector cable is required for a dual-drive system. On one end of the cable is a 34-pin flat-cable connector. On the other end are two sets of floppy disk drive connectors. Each set consists of a 34-pin flat-cable connector (usually used for 3.5" drives) and a printed-circuit board connector (usually used for 5.25" drives).

2.10.1 Connecting the floppy drive

1. Plug the 34-pin flat-cable connector into CN18. Make sure that the red wire corresponds to pin one on the connector.
2. Attach the appropriate connector on the other end of the cable to the floppy drive(s). You can use only one connector in the set. The set on the end (after the twist in the cable) connects to the A: drive. The set in the middle connects to the B: drive.
3. If you are connecting a 5.25" floppy drive, line up the slot in the printed circuit board with the blocked-off part of the cable connector.

If you are connecting a 3.5" floppy drive, you may have trouble determining which pin is number one. Look for a number printed on the circuit board indicating pin number one. In addition, the connector on the floppy drive may have a slot. When the slot is up, pin number one should be on the right. Check the documentation that came with the drive for more information.

If you desire, connect the B: drive to the connectors in the middle of the cable as described above.

In case you need to make your own cable, you can find the pin assignments for the board's connector in Appendix C.

2.11 Parallel port connector (CN15)

Normally, the parallel port is used to connect the card to a printer. The PCM-9575 includes a multi-mode (ECP/EPP/SPP) parallel port accessed via CN15 and a 26-pin flat-cable connector. You will need an adapter cable if you use a traditional DB-25 connector. The adapter cable has a 26-pin connector on one end, and a DB-25 connector on the other.

The parallel port is designated as LPT1, and can be disabled or changed to LPT2 or LPT3 in the system BIOS setup.

The parallel port interrupt channel is designated to be IRQ7.

You can select ECP/EPP DMA channel via BIOS setup.

2.12 Keyboard and PS/2 mouse connector (CN25)

The PCM-9575 board provides a keyboard connector that supports both a keyboard and a PS/2 style mouse. In most cases, especially in embedded applications, a keyboard is not used. If the keyboard is not present, the standard PC/AT BIOS will report an error or fail during power-on self-test (POST) after a reset. The PCM-9575's BIOS standard setup menu allows you to select "All, But Keyboard" under the "Halt On" selection. This allows no-keyboard operation in embedded system applications, without the system halting under POST.

2.13 Power & HDD LED, Reset Button Connector (CN13, CN22)

Next, you may want to install external switches to monitor and control the PCM-9575. These features are optional: install them only if you need

them. The front panel connector (CN13) is an 8-pin male, dual in-line header. It provides connections for a speaker, hard disk access indicator, watchdog output, and an input switch for resetting the card.

2.13.1 Power & HDD LED (CN13)

The HDD LED indicator for hard disk access is an active low signal (24 mA sink rate). Power supply activity LED indicator.

2.13.2 Reset switch (CN22)

If you install a reset switch, it should be an open single pole switch. Momentarily pressing the switch will activate a reset. The switch should be rated for 10 mA, 5 V.

2.14 Power connectors (CN27, CN5, FAN1)

2.14.1 Peripheral power connector, -5 V, -12 V (CN27)

Supplies secondary power to devices that require -5 V and -12 V.

2.14.2 Main power connector, +5 V, +12 V (CN5)

Supplies main power to the PCM-9575 (+5 V), and to devices that require +12 V.

2.14.3 CPU Fan power supply connector (FAN1)

Provides power supply to CPU cooling fan. Only present when +5 V and +12 V power is supplied to the board.

2.15 ATX power control connector (CN3, CN23)

2.15.1 ATX feature connector (CN3) and soft power switch connector (CN23)

The PCM-9575 can support an advanced soft power switch function, if an ATX power supply is used. To enable the soft power switch function:

1. Get the specially designed ATX-to-EBX power cable (PCM-9575 optional item, part no. 1703200100)
2. Connect the 3-pin plug of the cable to CN3 (ATX feature connector).
3. Connect the power on/off button to CN23. (A momentary type of button should be used.)

Important *Make sure that the ATX power supply can take at least a 10 mA load on the 5 V standby lead (5VSB). If not, you may have difficulty powering on your system.*

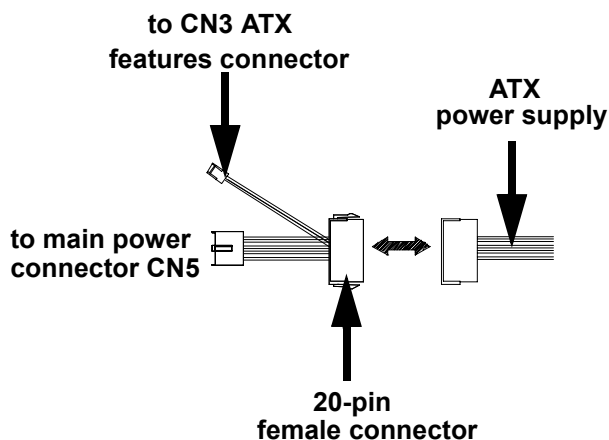

Figure 2.3: Wiring for ATX soft power switch function

2.16 IR connector (CN24)

This connector supports the optional wireless infrared transmitting and receiving module. This module mounts on the system case. You must configure the setting through BIOS setup.

2.17 Audio interfaces (CN4, CN2)

The PCM-9575 is equipped with a high-quality audio interface, which provides 16-bit CD-quality recording and playback as well as OPL3 compatible FM music. It is supported by all major operating systems.

2.17.1 Audio connector (CN4)

The PCM-9575 provides all major audio signals on a 16-pin flat-cable connector, CN4. These audio signals include Microphone in (mono), Line in (stereo), Line out (stereo), and Speaker out (stereo). If you use traditional telephone jack connectors for these audio signals, you will need an adapter cable.

2.17.2 CD audio input connector (CN2)

Any CD-ROM drive can provide analog audio signal output when used as a music CD player. The CN2 on PCM-9575 is a connector to input CD audio signals into the audio controller. The audio cable of your CD-ROM drive will be used to connect to CN2.

2.18 COM port connector (CN19)

The PCM-9575 provides four serial ports (COM1, 3, 4: RS-232; COM2: RS-232/422/485) in one COM port connector. The COM port connector is a 40-pin, dual-inline, male header. It provides connections for serial devices (a mouse, etc.) or a communication network. You can find the pin assignments for the COM port connector in Appendix C.

2.18.1 COM2 RS-232/422/485 setting (JP6)

COM2 can be configured to operate in RS-232, RS-422, or RS-485 mode. This is done via JP6

JP6: COM2 RS-232/422/485 select

PINS	RS-232*	RS-422	RS-485
1-2	Open	Open	Closed
3-4	Open	Closed	Open
5-6	Closed	Open	Open
7-9	Closed	Open	Open
8-10	Closed	Open	Open
9-11	Open	Closed	Closed
10-12	Open	Closed	Closed
13-15	Closed	Open	Open
14-16	Closed	Open	Open
15-17	Open	Closed	Closed
16-18	Open	Closed	Closed

2.19 VGA/LCD/LVDS interface connections

The PCM-9575's PCI SVGA interface can drive conventional CRT displays and is capable of driving a wide range of flat panel displays, including passive LCD and active LCD displays. The board has three connectors to support these displays: one for standard CRT VGA monitors, one for flat panel displays, and one for LVDS type LCD panels.

2.19.1 CRT display connector (CN8)

CN8 is a 16-pin, dual-inline header used for conventional CRT displays. A simple one-to-one adapter can be used to match CN8 to a standard 15-pin D-SUB connector commonly used for VGA.

Pin assignments for CRT display connector CN8 are detailed in Appendix C.

2.19.2 Flat panel display connector (CN11)

CN11 consists of a 40-pin connector which can support a 24-bit LCD panel. It is Hirose's product no. DF13A-40DP-1.25 V

The PCM-9575 provides a bias control signal on CN11 that can be used to control the LCD bias voltage. It is recommended that the LCD bias voltage not be applied to the panel until the logic supply voltage (+5 V or +3.3 V) and panel video signals are stable. Under normal operation, the control signal (ENAVEE) is active high. When the PCM-9575's power is applied, the control signal is low until just after the relevant flat panel signals are present. CN11 can connect up to 24 bit TFT LCD.

2.19.3 Extension flat panel connector (CN10)

CN10 consists of a 20-pin connector which is Hirose's product no. DF13A-20DP-1.25V. The PCM-9575 supports a 36-bit LCD panel which must be connected to both the CN11 (40-pin) and the CN10 (20-pin). The pin assignments for both CN11 and the CN10 can be found in Appendix C

2.19.4 LVDS LCD panel connector (CN9)

The PCM-9575 uses the VIA Twister chip that supports 2 channel (2 x 18 bit) LVDS LCD panel displays. Users can connect to either an 18-bit or 36-bit LVDS LCD with CN9.

2.19.5 Panel type selection (S1)

S1 is an 8 segment DIP switch for DSTN/TFT panel type and resolution functions.

Table 2.4: S1 Panel Type select

SW 1-1	SW 1-2	SW 1-3	SW 1-4	Panel Type & Resolution		
ON	ON	ON	ON	TFT	640x480**	18bit (H. V. Freq)
ON	ON	ON	OFF	TFT	648x480	18bit (Synthetic)
ON	ON	OFF	ON	TFT	648x480**	N/A
ON	ON	OFF	OFF	TFT	648x480**	LVDS
ON	OFF	ON	ON	DSTN	648x480**	18bit
ON	OFF	ON	OFF	TFT	800x600**	18bit (H. V. Freq)
ON	OFF	OFF	ON	TFT	800x600*	18bit (Synthetic)
ON	OFF	OFF	OFF	TFT	800x600	LVDS
OFF	ON	ON	ON	TFT	800x600**	N/A
OFF	ON	ON	OFF	DSTN	800x600**	18bit
OFF	ON	OFF	ON	TFT	1024x768**	36bit (H. V. Freq)
OFF	ON	OFF	OFF	TFT	1024x768	36bit (Synthetic)
OFF	OFF	ON	ON	TFT	1024x768**	LVDS
OFF	OFF	ON	OFF	TFT	1024x768**	N/A
OFF	OFF	OFF	ON	DSTN	1024x768**	18bit
OFF	OFF	OFF	OFF	DSTN	1024x768**	24bit

* Default setting

** will support in the future

2.20 TV-out interface (optional) (CN1)

The PCM-9575 board provides optional TV-out via CN1. This consists of a 5-pin wafer box header. Output supports composite video and S-video connectors via an optional cable kit (p/n: 1103050306). TV-out generators use both NTSC and PAL formats.

To set up your video interface:

1. Run the appropriate installation program located on the utility disk. That's all there is to it.

2.21 Ethernet configuration

The PCM-9575 is equipped with a high performance 32-bit PCI-bus Ethernet interface which is fully compliant with IEEE 802.3U 10/100Mbps CSMA/CD standards. It is supported by all major network operating systems.

The medium type can be configured via the RSET8139.EXE program included on the utility disk. (See Chapter 3 for detailed information.)

2.21.1 100Base-T connector (CN12)

10/100Base-T connects to the PCM-9575 via an adapter cable to a 10-pin polarized header (CN12).

2.21.2 Network boot

The Network Boot feature can be utilized by incorporating the Boot ROM image files for the appropriate network operating system. The Boot ROM BIOS files are included in the system BIOS, which is on the utility CD disc.

2.21.3 LAN controller power select (JP2)

Table 2.5: LAN controller power select (JP2)

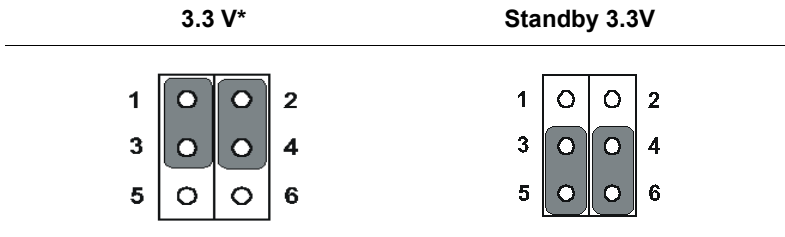

* default setting

Note: PCM-9575 supports Wake-on-LAN. For Wake-on LAN, J6 has to be set to the Standby 3.3 V position

2.22 Watchdog timer configuration

An on-board watchdog timer reduces the chance of disruptions which EMP (electro-magnetic pulse) interference can cause. This is an invaluable protective device for standalone or unmanned applications. Setup

involves one jumper and running the control software (refer to Appendix A).

2.22.1 Watchdog timer action (JP5)

When the watchdog timer activates (CPU processing has come to a halt), it can reset the system or generate an interrupt on IRQ11. This can be set via setting JP5 as shown below:

Table 2.6: Watchdog timer action (JP5)

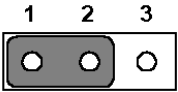
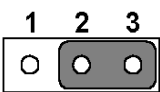
*System reset	IRQ 11
	

* default setting

2.23 USB connectors (CN20, CN28)

The PCM-9575 board provides up to four USB (Universal Serial Bus) ports, with USB3 and USB4 optional. This gives complete Plug and Play, and hot attach/detach for up to 127 external devices. The USB interfaces comply with USB specification Rev. 1.1, and are fuse protected.

The USB interface is accessed through two 5 x 2-pin flat-cable connectors, CN20 (USB1, 2); and CN28 (USB3, 4). You will need an adapter cable if you use a standard USB connector. The adapter cable has a 5 x 2-pin connector on one end and a USB connector on the other.

The USB interfaces can be disabled in the system BIOS setup.

Software Configuration

This chapter details the software configuration information. It shows you how to configure the card to match your application requirements. The AWARD System BIOS is covered in Chapter 4.

Sections include:

- Introduction
- Connections for standard LCDs
- Ethernet interface configuration.

Chapter 3 Software Configuration

3.1 Introduction

The PCM-9575 system BIOS and custom drivers are located in a 256 Kbyte, Flash ROM device, designated U18. A single Flash chip holds the system BIOS, VGA BIOS and network Boot ROM image. The display can be configured via CMOS settings. This method minimizes the number of chips and difficulty of configuration. To set different types of LCD panels, please choose “panel type” from the “integrated peripherals” menu in CMOS setup.

3.2 Connections to Three Standard LCDs

The following tables illustrate typical LCD connection pinouts for the PCM-9575.

3.2.1 Connections to Toshiba LTM10C209A (640 x 480 TFT color LCD)

Table 3.1: Connections to Toshiba LTM10C209A

LTM10C209A		PCM-9575 CN11	
Pin	Name	Pin	Name
1	GND	3	GND
2	CLK	35	SHFCLK
3	GND	34	GND
4	R0	27	P18
5	R1	28	P19
6	R2	29	P20
7	GND	33	GND
8	R3	30	P21
9	R4	31	P22
10	R5	32	P23
11	GND	34	GND
12	G0	19	P10
13	G1	20	P11
14	G2	21	P12
15	GND	8	GND
16	G3	22	P13
17	G4	23	P14
18	G5	24	P15
19	GND	8	GND
20	ENAB	37	M/DE
21	GND	4	GND
22	B0	11	P2
23	B1	12	P3
24	B2	13	P4
25	GND	4	GND
26	B3	14	P5
27	B4	15	P6

Table 3.1: Connections to Toshiba LTM10C209A

28	B5	16	P7
29	GND	3	GND
30	VDD	1	+5 V
31	VDD	2	+5 V

3.2.2 Connections to Toshiba LTM15C151A (1024 x 768 TFT color LCD)**Table 3.2: Connections to Toshiba LTM15C151A**

LTM15C151A		PCM-9575 CN11	
Pin	Name	Pin	Name
CN1-1	GND	CN 11-33	GND
CN1-2	NCLK	CN 11-35	LDSCCLK1
CN1-3	NC		
CN1-4	NC		
CN1-5	GND	CN 11-3	GND
CN1-6	OR0	CN 11-9	PD0
CN1-7	OR1	CN 11-11	PD2
CN1-8	OR2	CN 11-13	PD4
CN1-9	OR3	CN 11-15	PD6
CN1-10	OR4	CN 11-17	PD8
CN1-11	OR5	CN 11-19	PD10
CN1-12	GND	CN 11-3	GND
CN1-13	OG0	CN 11-21	PD12
CN1-14	OG1	CN 11-23	PD14
CN1-15	OG2	CN 11-25	PD16
CN1-16	OG3	CN 11-27	PD18
CN1-17	OG4	CN 11-29	PD20
CN1-18	OG5	CN 11-31	PD22
CN1-19	GND	CN 10-1	GND
CN1-20	OB0	CN 10-3	PD24
CN1-21	OB1	CN 10-5	PD26
CN1-22	OB2	CN 10-7	PD28
CN1-23	OB3	CN 10-9	PD30
CN1-24	OB4	CN 10-11	PD32

Table 3.2: Connections to Toshiba LTM15C151A

CN1-25	OB5	CN 10-13	PD34
CN1-26	ENAB	CN 11-37	M/DE
CN1-27	GND	CN 11-34	GND
CN1-28	VDD	CN 11-1	+5V
CN1-29	VDD	CN 11-2	+5V
CN1-30	GND	CN 11-8	GND

3.2.3 Connections to Toshiba LTM12C275A (800 x 600 TFT color LCD)

Table 3.3: Connections to Toshiba LTM12C275A

LTM12C275A		PCM-9575 CN11	
Pin	Name	Pin	Name
1	GND	3	GND
2	NCLK	35	SHFCLK
3	NC	-	NC
4	NC	-	NC
5	GND	4	GND
6	R0	27	P18
7	R1	28	P19
8	R2	29	P20
9	R3	30	P21
10	R4	31	P22
11	R5	32	P23
12	GND	8	GND
13	G0	19	P10
14	G1	20	P11
15	G2	21	P12
16	G3	22	P13
17	G4	23	P14
18	G5	24	P15
19	GND	33	GND
20	B0	11	P2
21	B1	12	P3
22	B2	13	P4

Table 3.3: Connections to Toshiba LTM12C275A

23	B3	14	P5
24	B4	15	P6
25	B5	16	P7
26	ENAB	37	M/DE
27	GND	34	GND
28	VCC	5	+5 V
29	VCC	6	+5 V
30	GND	39	GND

3.3 Ethernet software configuration

The PCM-9575's on-board Ethernet interface supports all major network operating systems. To configure the medium type, to view the current configuration, or to run diagnostics, do the following:

1. Power the PCM-9575 on. Make sure that the RSET8139.EXE file is located in the working drive.
2. At the prompt, type RSET8139.EXE and press <Enter>. The Ethernet configuration program will then be displayed.
3. This simple screen shows all the available options for the Ethernet interface. Just highlight the option you wish to change by using the Up and Down keys. To change a selected item, press <Enter>, and a screen will appear with the available options. Highlight your option and press <Enter>. Each highlighted option has a helpful message guide displayed at the bottom of the screen for additional information.
4. After you have made your selections and are sure this is the configuration you want, press ESC. A prompt will appear asking if you want to save the configuration. Press Y if you want to save.

The Ethernet Setup Menu also offers three very useful diagnostic functions. These are:

1. Run EEPROM Test.
2. Run Diagnostics on Board.
3. Run Diagnostics on Network.

Each option has its own display screen that shows the format and result of any diagnostic tests undertaken.

Note *For Ethernet installation, please see Chapter 7*

CHAPTER 4

Award BIOS Setup

This chapter describes how to set BIOS configuration data.

Chapter 4 Award BIOS Setup

4.1 System test and initialization

These routines test and initialize board hardware. If the routines encounter an error during the tests, you will either hear a few short beeps or see an error message on the screen. There are two kinds of errors: fatal and non-fatal. The system can usually continue the boot up sequence with non-fatal errors. Non-fatal error messages usually appear on the screen along with the following instructions:

press <F1> to RESUME

Write down the message and press the F1 key to continue the bootup sequence.

4.1.1 System configuration verification

These routines check the current system configuration against the values stored in the board's CMOS memory. If they do not match, the program outputs an error message. You will then need to run the BIOS setup program to set the configuration information in memory.

There are three situations in which you will need to change the CMOS settings:

1. You are starting your system for the first time
2. You have changed the hardware attached to your system
3. The CMOS memory has lost power and the configuration information has been erased.

The PCM-9575 Series' CMOS memory has an integral lithium battery backup. The battery backup should last ten years in normal service, but when it finally runs down, you will need to replace the complete unit.

4.2 Award BIOS setup

Award's BIOS ROM has a built-in Setup program that allows users to modify the basic system configuration. This type of information is stored in battery-backed CMOS RAM so that it retains the Setup information when the power is turned off.

4.2.1 Entering setup

Power on the computer and press immediately. This will allow you to enter Setup.

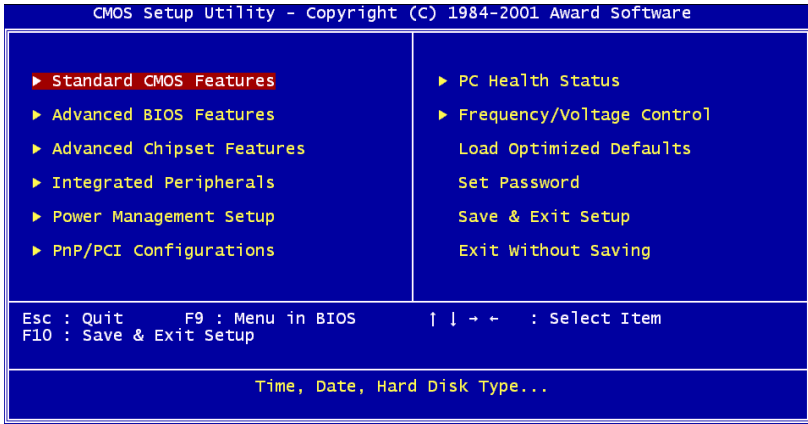

Figure 4.1: BIOS setup program initial screen

4.2.2 Standard CMOS Features setup

When you choose the Standard CMOS Features option from the Initial Setup Screen menu, the screen shown below is displayed. This standard Setup Menu allows users to configure system components such as date, time, hard disk drive, floppy drive and display. Once a field is highlighted, on-line help information is displayed in the left bottom of the Menu screen.

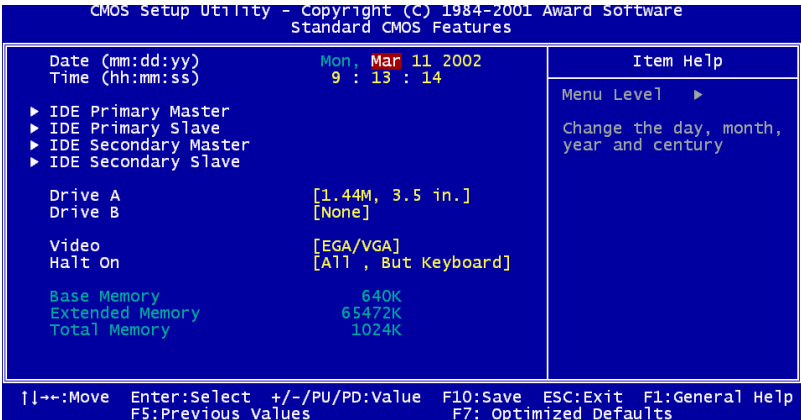

Figure 4.2: CMOS Features setup

4.2.3 Advanced BIOS Features setup

By choosing the Advanced BIOS Features Setup option from the Initial Setup Screen menu, the screen below is displayed. This sample screen contains the manufacturer's default values for the PCM-9575 Series.

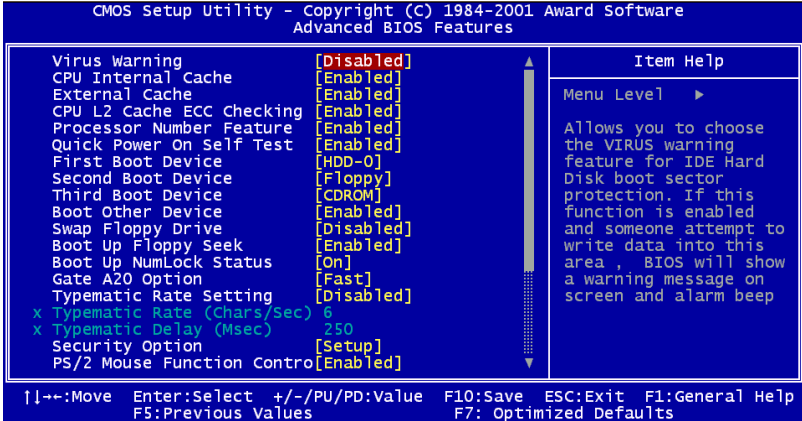

Figure 4.3: Advanced BIOS Features setup

4.2.4 Advanced Chipset Features setup

By choosing the Advanced Chipset Features option from the Initial Setup Screen menu, the screen below is displayed. This sample screen contains the manufacturer's default values for the PCM-9575 Series.

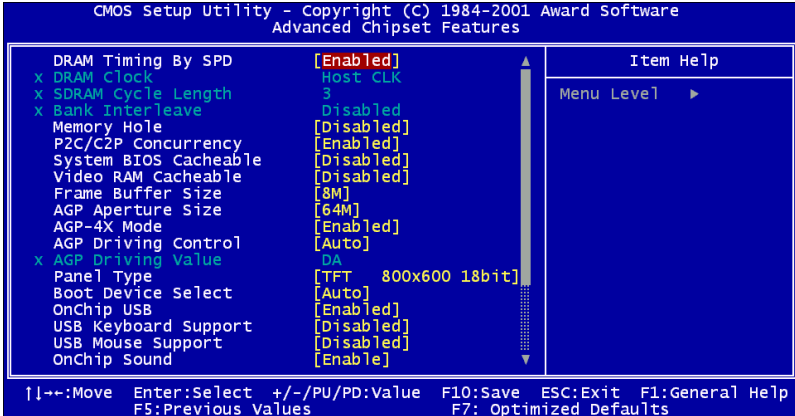

Figure 4.4: Advanced Chipset Features setup

4.2.5 Integrated Peripherals

Choosing the Integrated Peripherals option from the Initial Setup Screen menu should produce the screen below. Here we see the manufacturer's default values for the PCM-9575 Series.

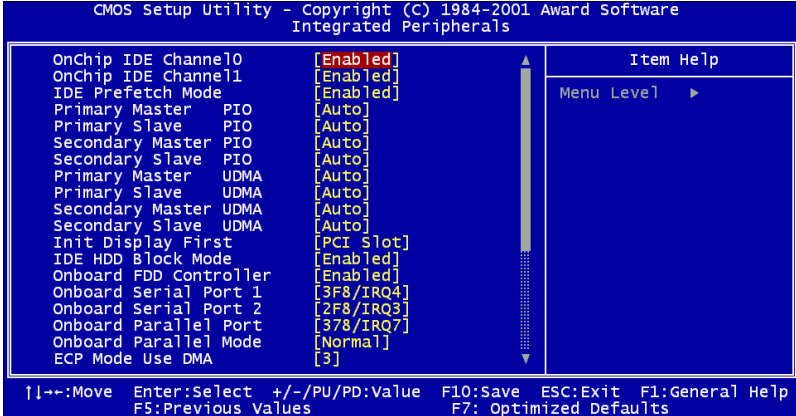

Figure 4.5: Integrated Peripherals

4.2.6 Power Management Setup

By choosing the Power Management Setup option from the Initial Setup Screen menu, the screen below is displayed. This sample screen contains the manufacturer's default values for the PCM-9575 Series.

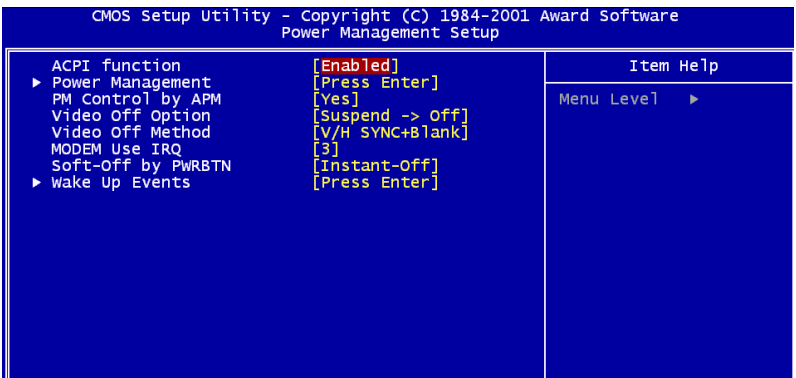

Figure 4.6: Power Management Setup

4.2.7 PnP/PCI Configurations

By choosing the PnP/PCI Configurations option from the Initial Setup Screen menu, the screen below is displayed. This sample screen contains the manufacturer's default values for the PCM-9575 Series.

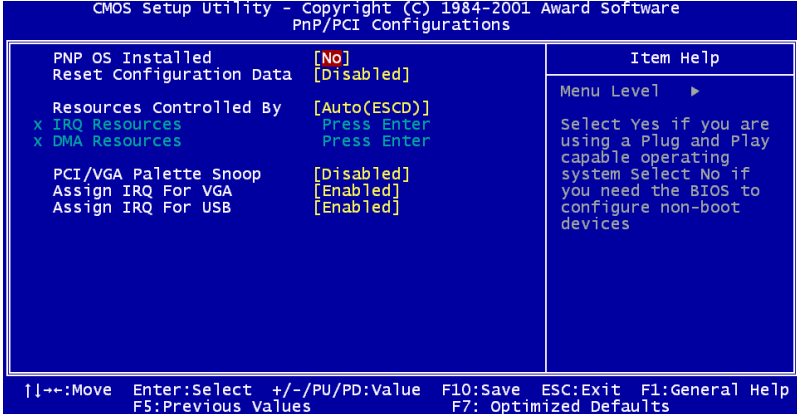

Figure 4.7: PnP/PCI Configurations

4.2.8 PC Health Status

The PC Health Status option displays information such as CPU and motherboard temperatures, fan speeds, and core voltage.

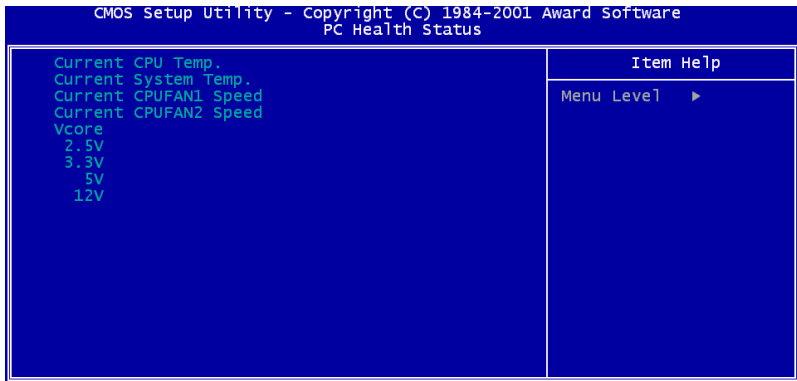

Figure 4.8: PC Health Status

4.2.9 Frequency/Voltage Control

By choosing the Frequency/Voltage Control option from the Initial Setup Screen menu, the screen below is displayed. This sample screen contains the manufacturer's default values for the PCM-9575

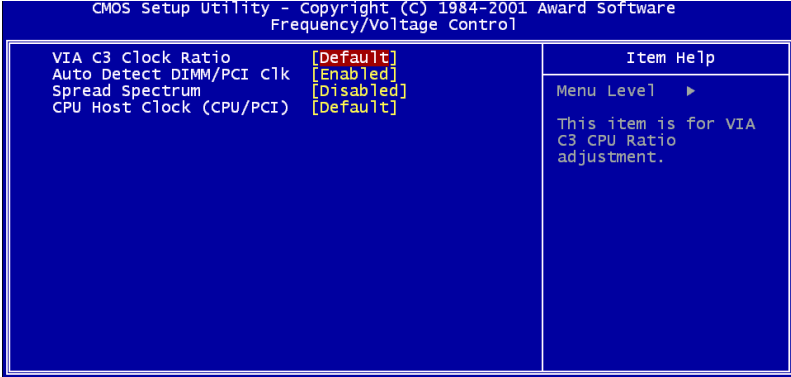

Figure 4.9: Frequency/Voltage Control

Caution *Incorrect settings in Frequency/Voltage Control may damage the system CPU, video adapter, or other hardware.*

4.2.10 Load Optimized Defaults

Load Optimized Defaults loads the default system values directly from ROM. If the stored record created by the Setup program should ever become corrupted (and therefore unusable), these defaults will load automatically when you turn the PCM-9575 Series system on.

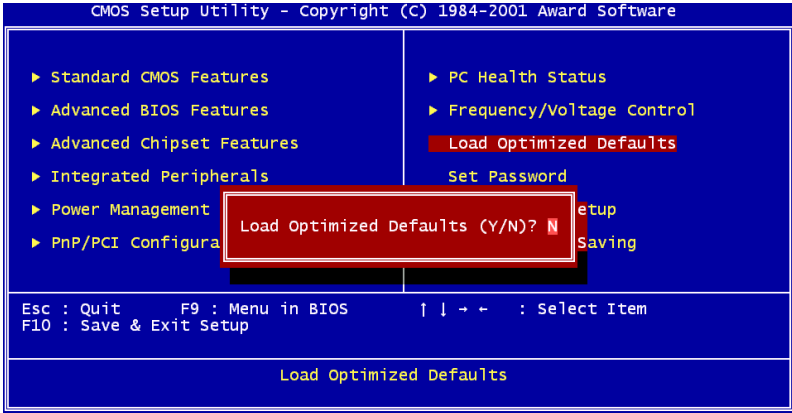

Figure 4.10: Load BIOS defaults screen

4.2.11 Set Password

Note *To enable this feature, you should first go to the Advanced BIOS Features menu, choose the Security Option, and select either Setup or System, depending on which aspect you want password protected. Setup requires a password only to enter Setup. System requires the password either to enter Setup or to boot the system.*

A password may be at most 8 characters long.

To Establish Password

1. Choose the Set Password option from the CMOS Setup Utility main menu and press <Enter>.
2. When you see “Enter Password,” enter the desired password and press <Enter>.

3. At the “Confirm Password” prompt, retype the desired password, then press <Enter>.
4. Select Save to CMOS and EXIT, type <Y>, then <Enter>.

To Change Password

1. Choose the Set Password option from the CMOS Setup Utility main menu and press <Enter>.
2. When you see “Enter Password,” enter the existing password and press <Enter>.
3. You will see “Confirm Password.” Type it again, and press <Enter>.
4. Select Set Password again, and at the “Enter Password” prompt, enter the new password and press <Enter>.
5. At the “Confirm Password” prompt, retype the new password, and press <Enter>.
6. Select Save to CMOS and EXIT, type <Y>, then <Enter>.

To Disable Password

1. Choose the Set Password option from the CMOS Setup Utility main menu and press <Enter>.
2. When you see “Enter Password,” enter the existing password and press <Enter>.
3. You will see “Confirm Password.” Type it again, and press <Enter>.
4. Select Set Password again, and at the “Enter Password” prompt, don’t enter anything; just press <Enter>.
5. At the “Confirm Password” prompt, again don’t type in anything; just press <Enter>.
6. Select Save to CMOS and EXIT, type <Y>, then <Enter>.

4.2.12 Save & Exit Setup

If you select this option and press <Y> then <Enter>, the values entered in the setup utilities will be recorded in the chipset’s CMOS memory. The microprocessor will check this every time you turn your system on and use the settings to configure the system. This record is required for the system to operate.

4.2.13 Exit Without Saving

Selecting this option and pressing <Enter> lets you exit the Setup program without recording any new values or changing old ones.

CHAPTER 5

PCI SVGA Setup

- Introduction
- Installation of SVGA drivers
 - for Windows 95/98/Me
 - for Windows NT/2000/XP
- Further information

Chapter 5 PCI SVGA Setup

5.1 Introduction

The PCM-9575 has an onboard AGP flat panel/VGA interface. The specifications and features are described as follows:

5.1.1 Chipset

The PCM-9575 uses a VIA Twister 8606T chipset from VIA Technology Inc. for its AGP/SVGA controller. It supports many popular LCD, and LVDS LCD displays and conventional analog CRT monitors. The VIA8606T VGA BIOS supports color TFT and DSTN LCD flat panel displays. In addition, it also supports interlaced and non-interlaced analog monitors (color and monochrome VGA) in high-resolution modes while maintaining complete IBM VGA compatibility. Digital monitors (i.e. MDA, CGA, and EGA) are NOT supported. Multiple frequency (multisync) monitors are handled as if they were analog monitors.

5.1.2 Display memory

The Twister chip can support 8/16/32MB frame buffer shared with system memory; the VGA controller can drive CRT displays or color panel displays with resolutions up to 1280 x 1024 at 16 M colors.

5.1.3 Display types

CRT and panel displays can be used simultaneously. The PCM-9575 can be set in one of three configurations: on a CRT, on a flat panel display, or on both simultaneously. The system is initially set to simultaneous display mode. If you want to enable the CRT display only or the flat panel display only, please contact VIA Technology Inc., or our sales representative for detailed information.

5.1.4 Dual/Simultaneous Display

The PCM-9575 uses a VIA Twister VT8606T LCD controller that is capable of providing simultaneous dual view display of the same content on a flat panel and CRT.

To set up dual view (simultaneous mode) under Windows 9x, Windows ME, Windows NT/2000/XP, follow these steps:

- Step 1. Open the Control panel, and select “Display”, “Settings”.
- Step 2. Select " CRT+LCD " or " CRT+TV " for dual view
- Step 3. Click “OK”.

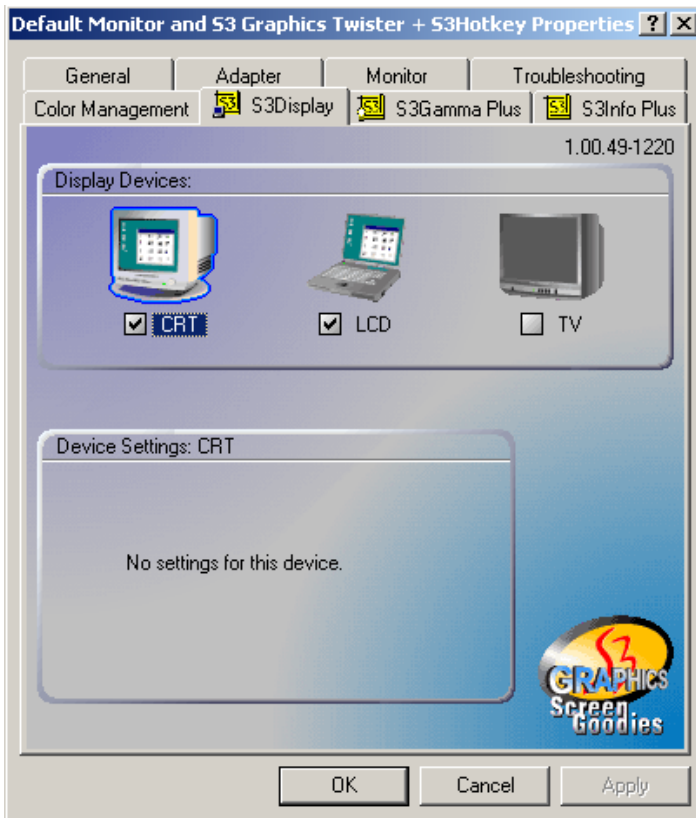

Figure 5.1: Selecting Display Settings

5.2 Installation of the SVGA Driver

Complete the following steps to install the SVGA driver. Follow the procedures in the flow chart that apply to the operating system that you are using within your PCM-9575.

- Notes:**
1. *The windows illustrations in this chapter are intended as examples only. Please follow the listed steps, and pay attention to the instructions which appear on your screen.*
 2. *For convenience, the CD-ROM drive is designated as "D" throughout this chapter.*

5.2.1 Installation for Windows 95

Step 1. Select "Start", "Settings", "Control Panel", "Display", "Settings", and "Advanced Properties".

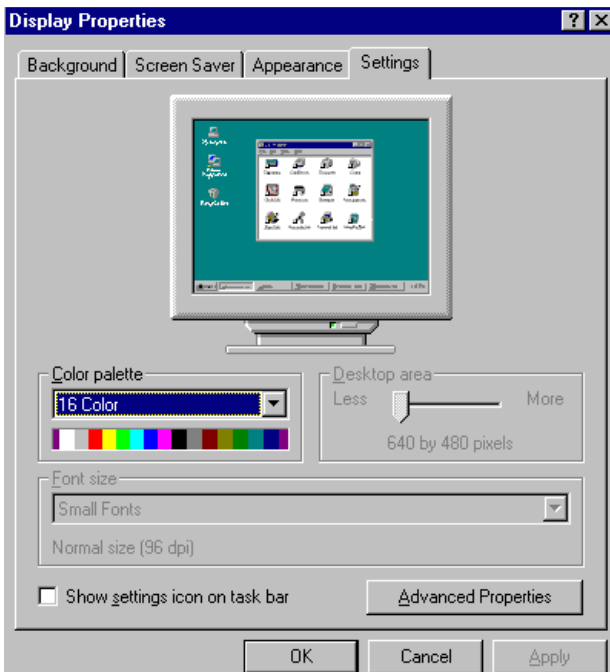

Step 2. Choose the "Adapter" tab, then press the "Change..." button.

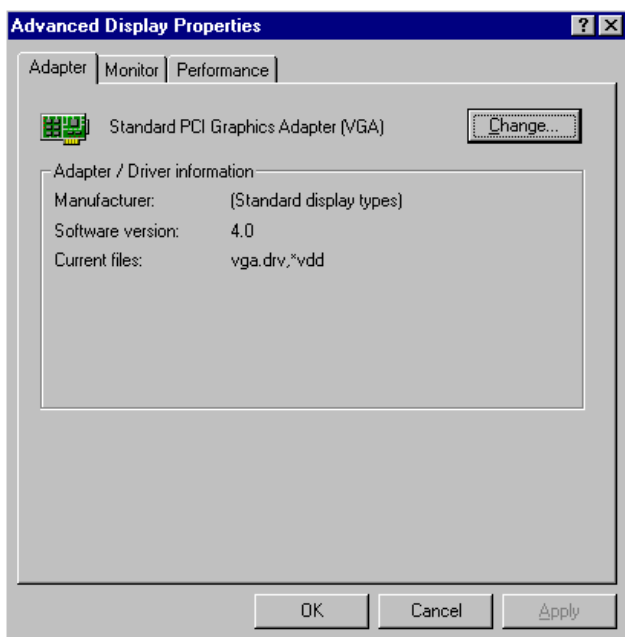

Step 3. Press the "Have Disk" button.

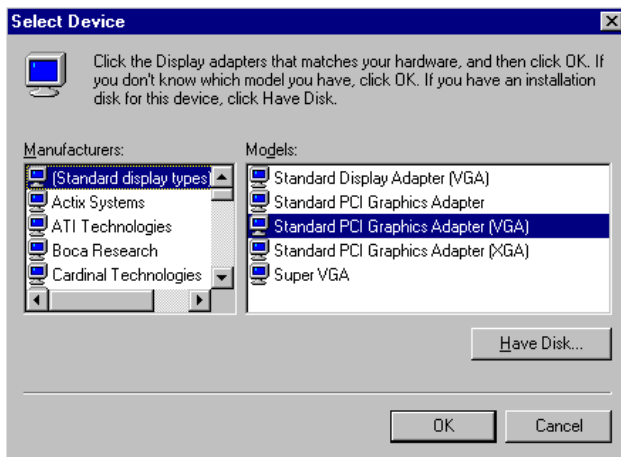

Step 4. Type in the path:

D:\Biscuit\9575\VGA\Win9x_Me

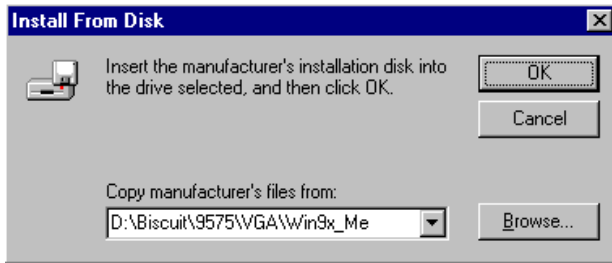

Step 5. Select the highlighted item, and click the "OK" button.

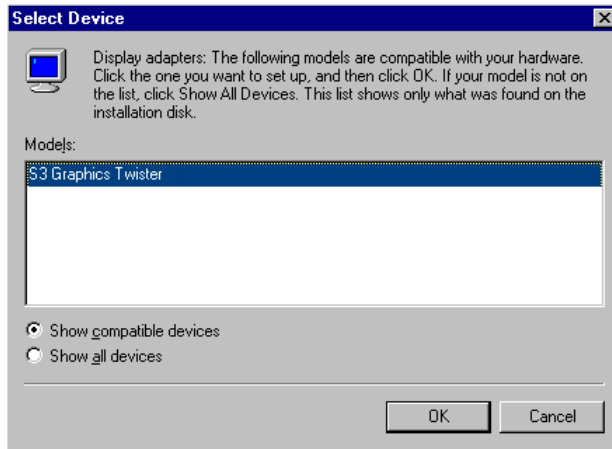

Step 6. "S3 GraphicsTwister" appears under the adapter tab. Click the "Apply" button, then the "OK" button.

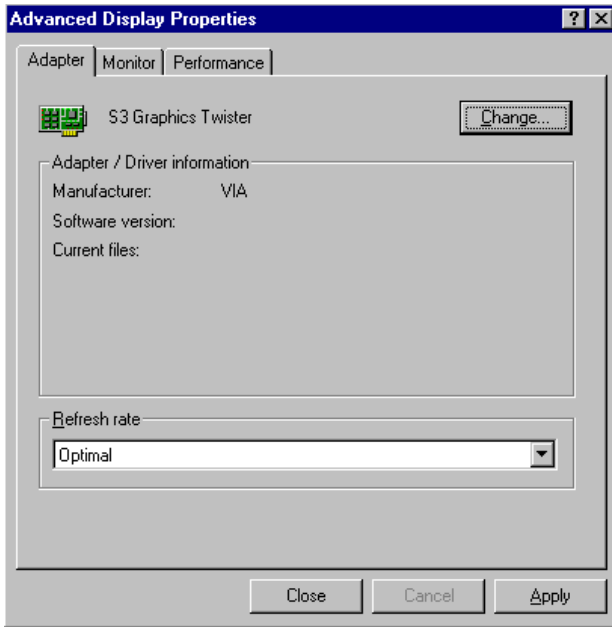

Step 7. Press "Yes" to reboot.

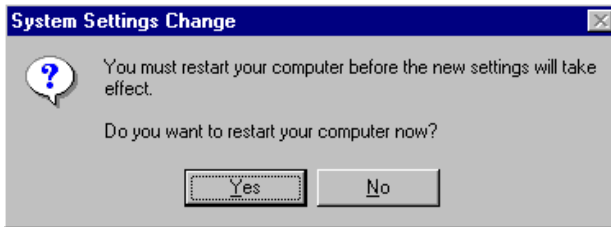

5.2.2 Installation for Windows 98/Me

Step 1. Select "Start", "Settings", "Control Panel", "Display", and "Settings," then press the "Advanced..." button.

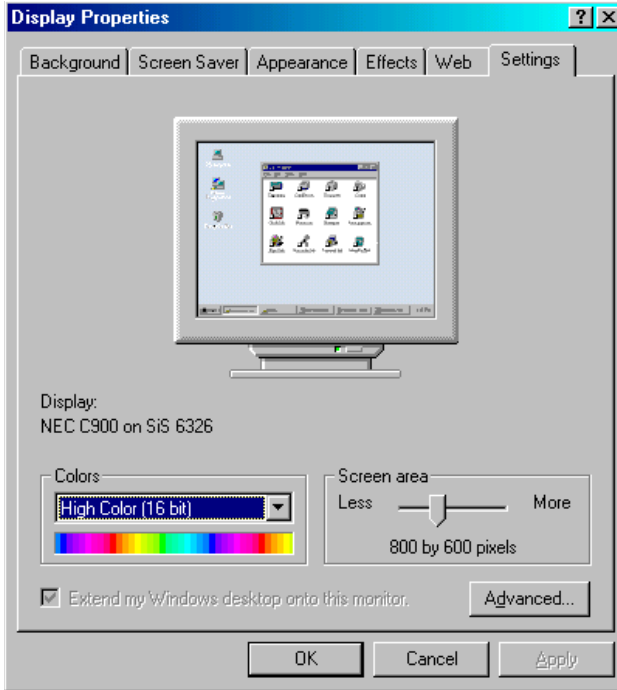

Step 2. Select “Adapter,” then “Change.”

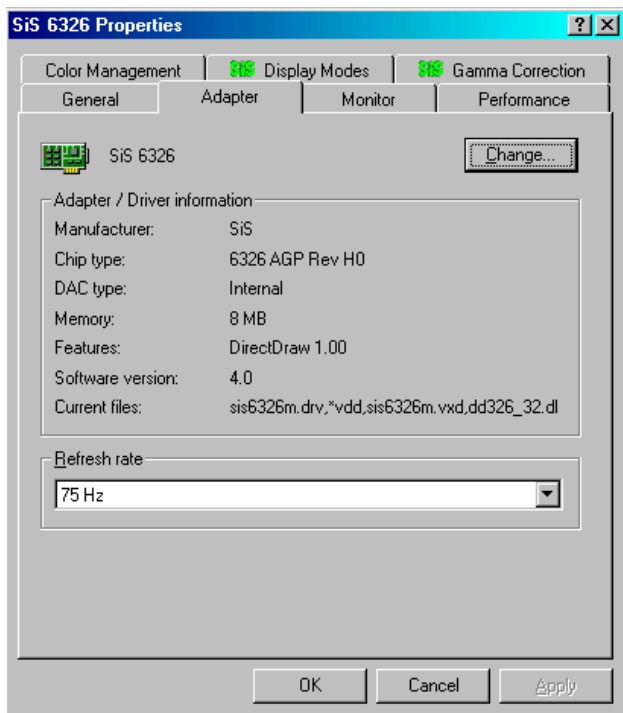

Step 3. Press “Next,” then “Display a list...”

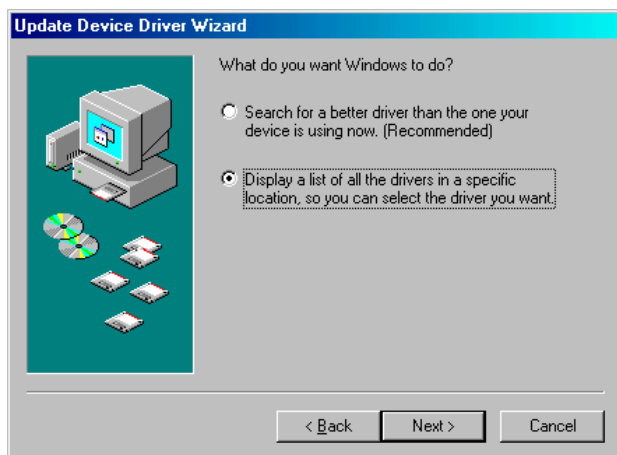

Step 4. Press the “Have disk...” button.

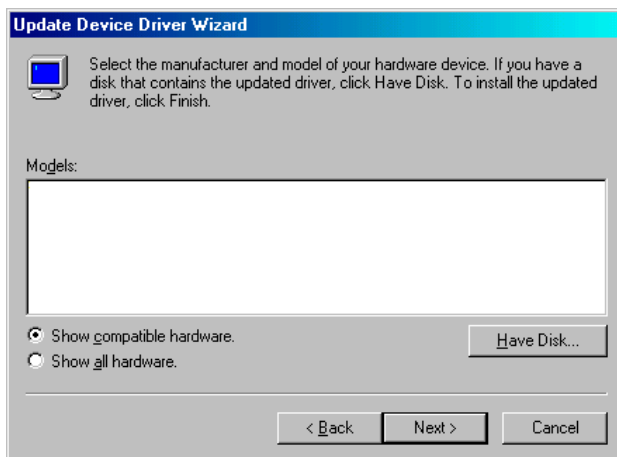

Step 5. Insert the CD into the CD-ROM drive. Type in the path **D:\Biscuit\9575\VGA\Win9x_Me**
Then press “OK”



Step 6. Select the highlighted item, then click “OK.”

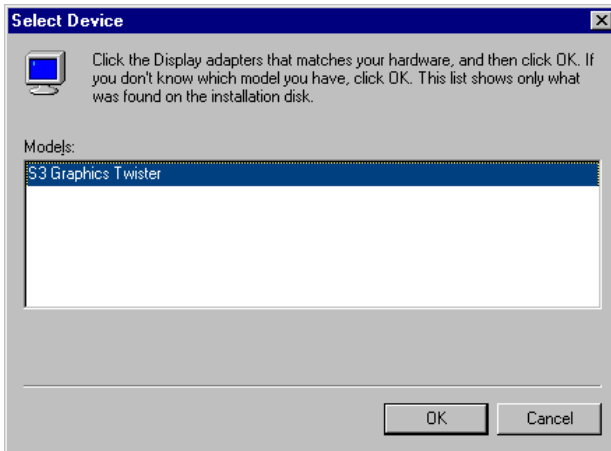

Step 7. "S3 Graphics Twister" appears under the adapter tab. Click the "Apply" button.

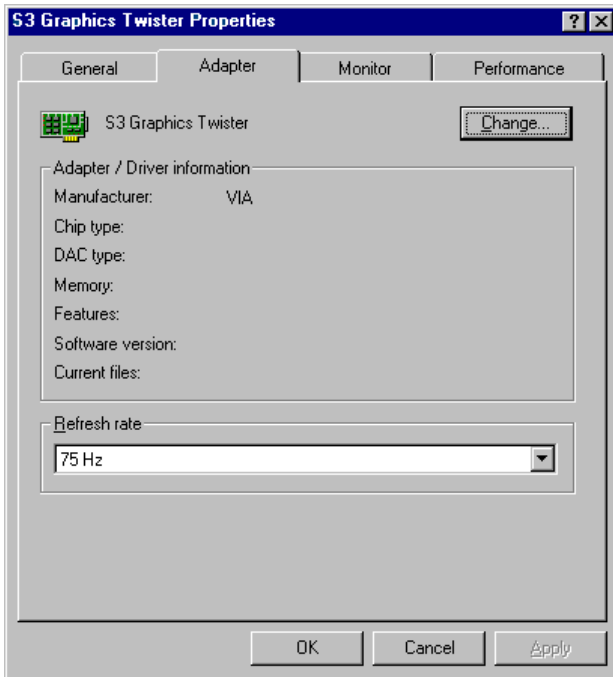

Step 8. Press "Yes" to reboot.

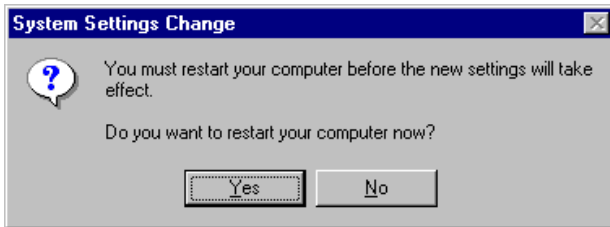

5.2.3 Installation for Windows NT

Note: Service Pack X (X = 3, 4, 5, 6,...) must be installed first, before you install the Windows NT VGA driver.

Step 1. Select "Start", "Settings", "Control Panel" and double click the "Display" icon.

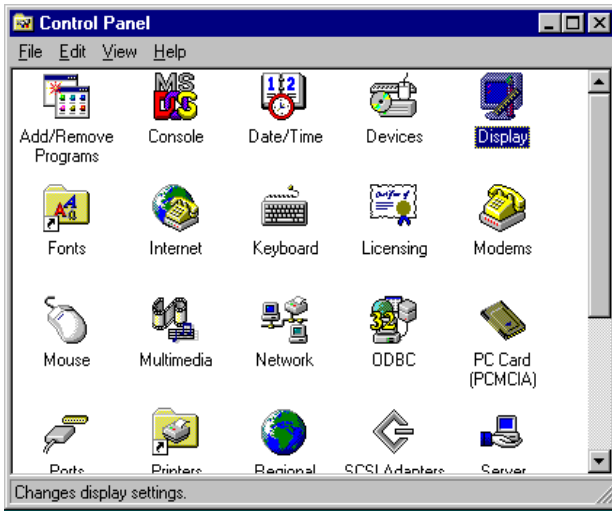

Step 2. Choose the "Settings" tab, and press the "Display Type" button.

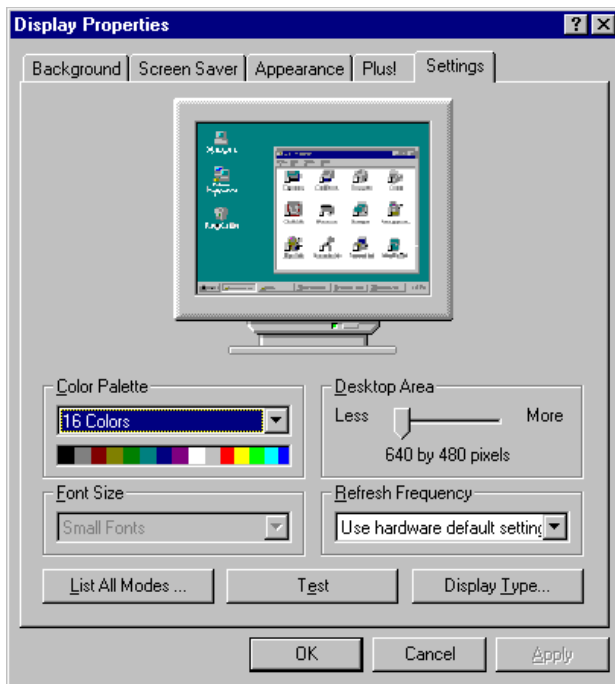

Step 3. Press the "Change..." button.

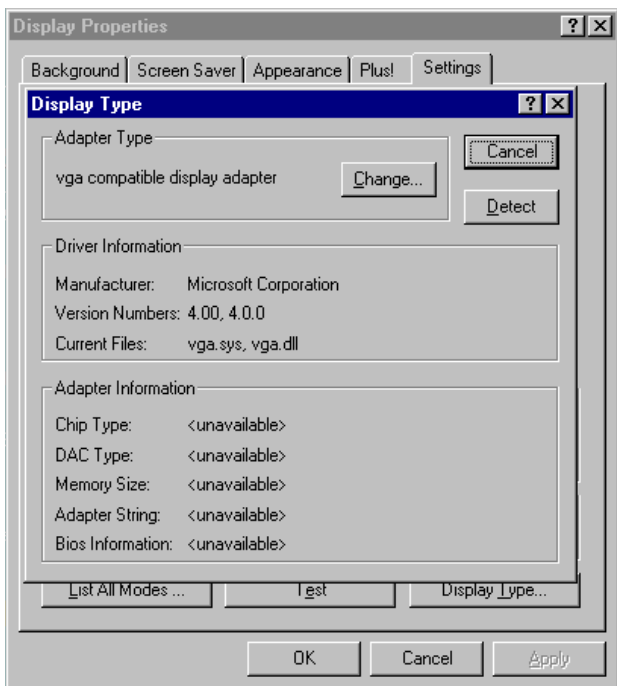

Step 4. Click the "Have Disk..." button.

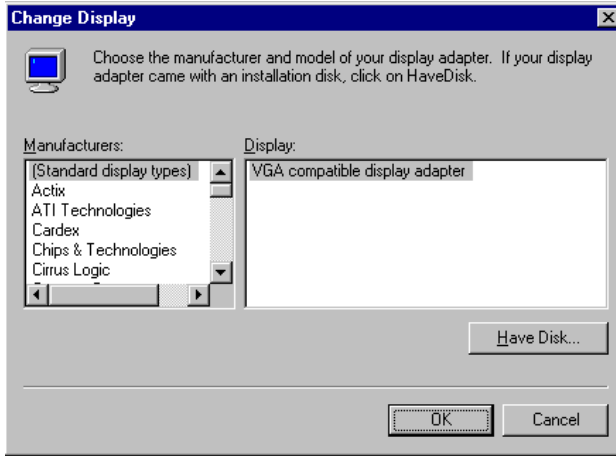

Step 5. Type the path:

D:\Biscuit\VGA\WinNT

Press the "OK" button.

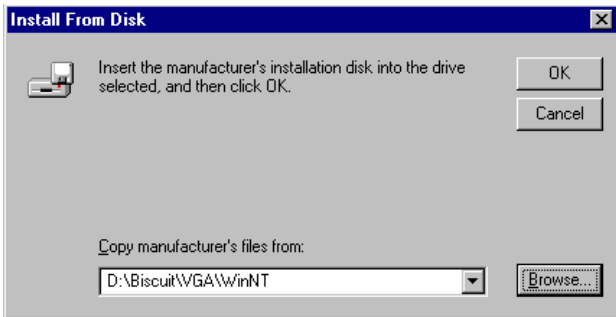

Step 6. Select the highlighted item, and click the "OK" button.

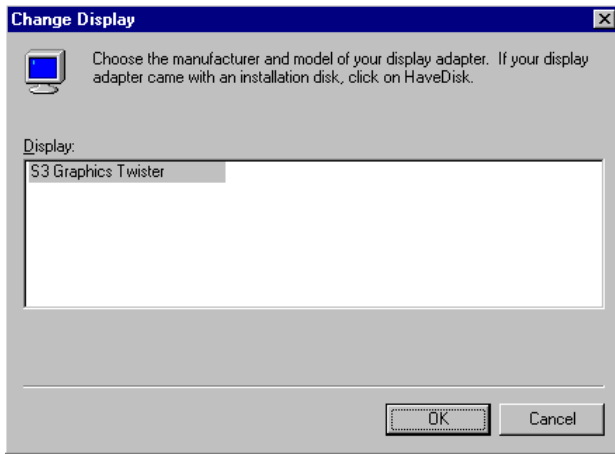

Step 7. Press "Yes" to proceed.

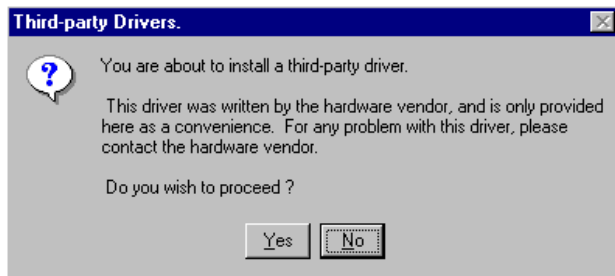

Step 8. Press "OK" to reboot.

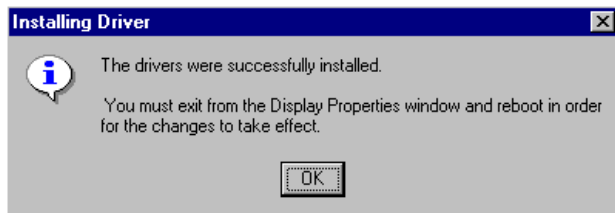

5.2.4 Installation for Windows 2000

Step 1. Select "System", "Settings", "Control Panel" and double click the "system" icon.

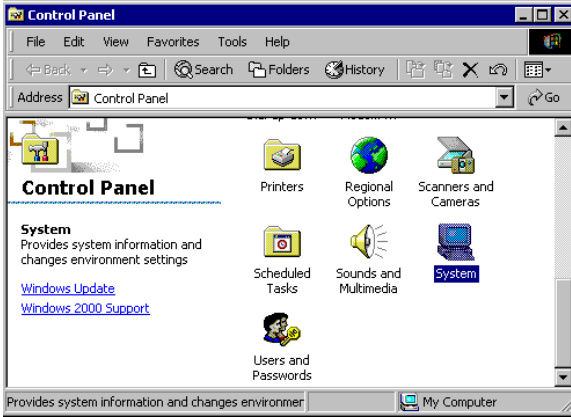

Step 2. Choose the "Video Controller (VGA Compatible)" button.

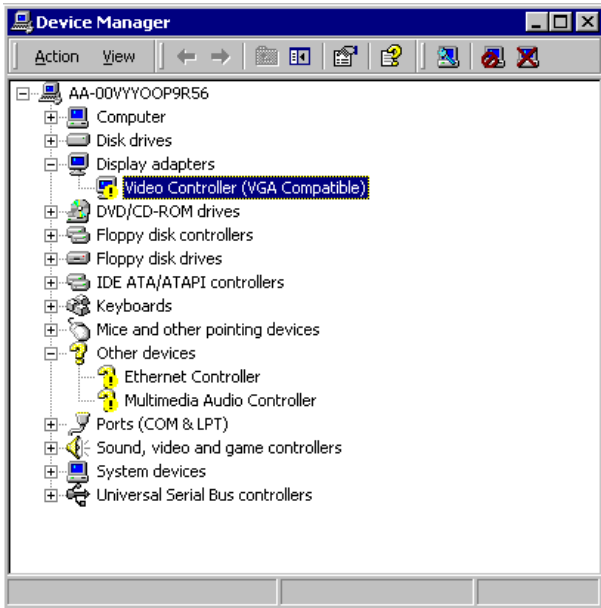

Step 3. Choose the "Drive" button, press "Update Driver..." button.



Step 4. Choose "Display a list of..." , then press "Next" button.



Step 5. Choose "Display adapters", press "Next" button.

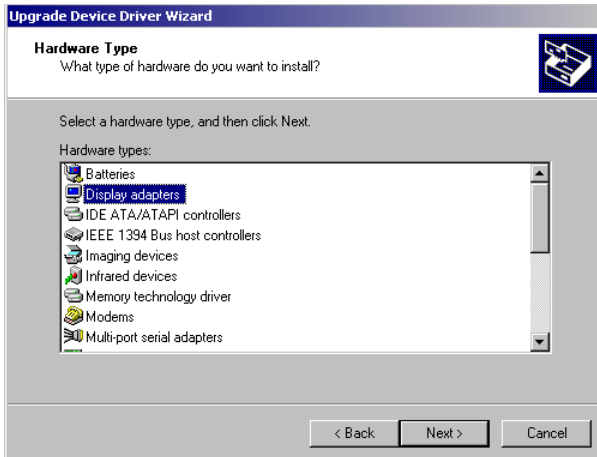

Step 6. Click the “Have Disk” button.

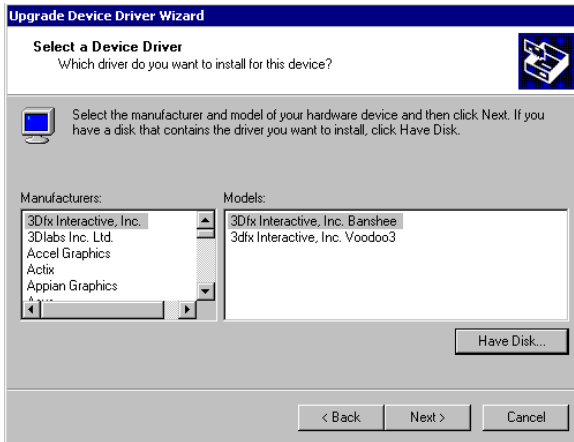

Step 7. Type the path D:\Biscuit\9575\VGA\Win2000 press the “OK” button.

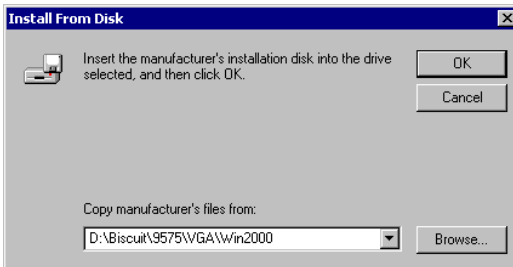

Step 8. Press "Finish" to reboot.



5.2.5 Installation for Windows XP

Step 1. Select "System", "Settings", "Control Panel" and double click the "system" icon.

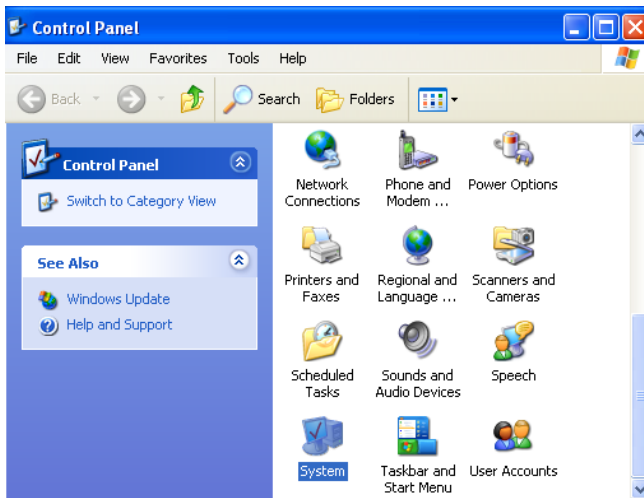

Step 2. Choose “Hardware” and “Device Manager”, press “OK” button.

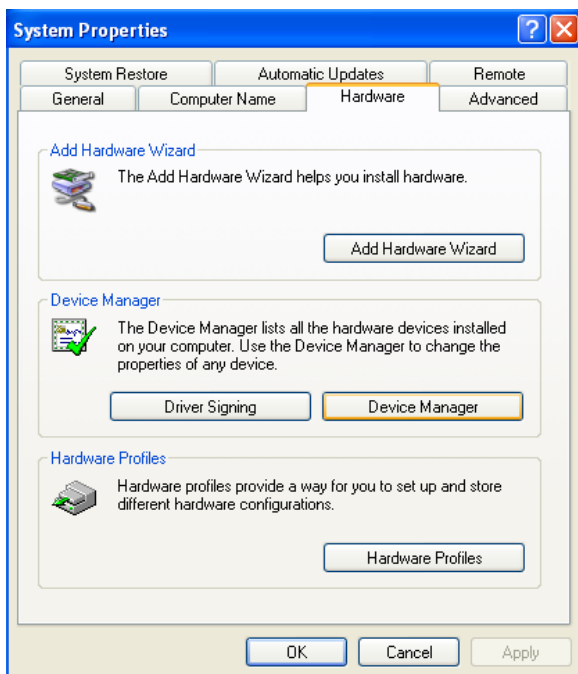

Step 3. Choose “Video Controller (VGA Compatible), press “OK” button.

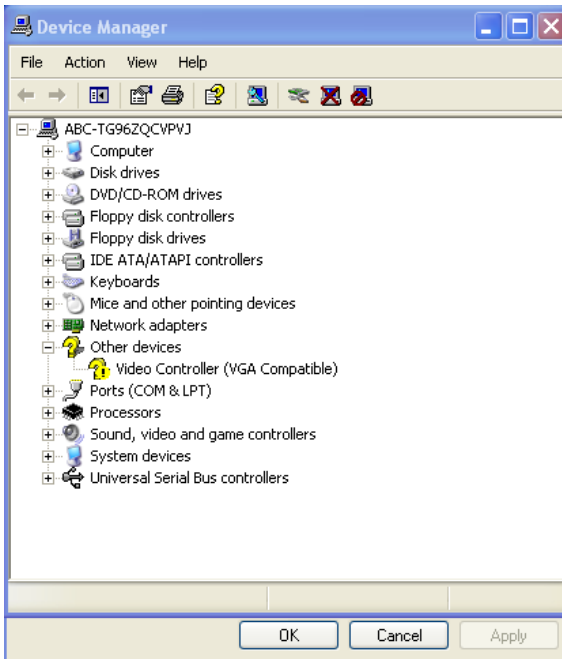

Step 4. Choose "Driver", "Update Driver", press "OK" button.

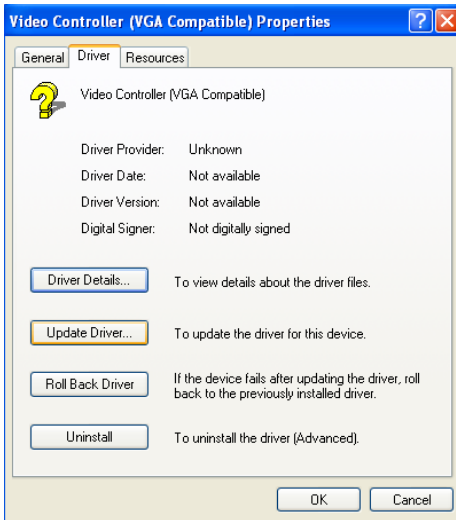

Step 5. Choose "Install from a list.....", press "Next".

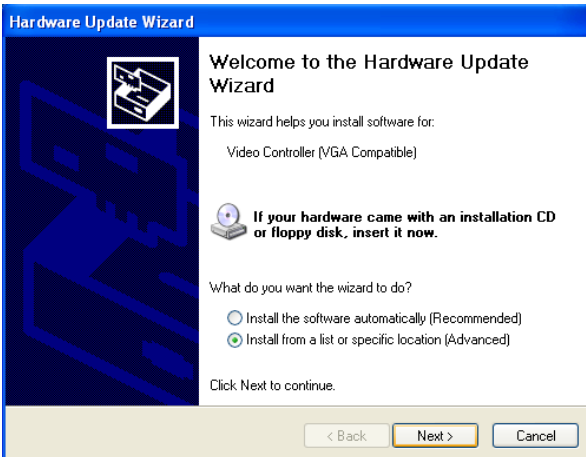

Step 6. Choose “Don’t search. I will...”, press “Next” button.

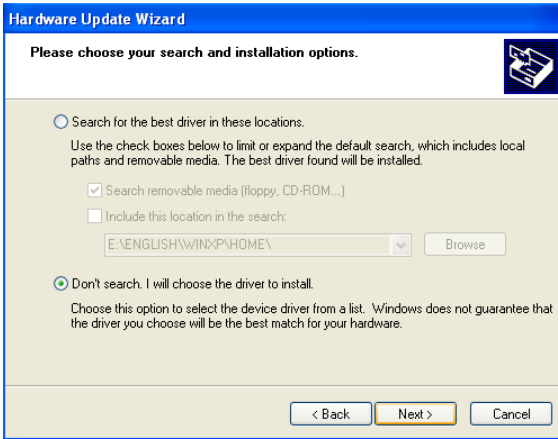

Step 7. Choose “Display adapters”, press “Next” button.

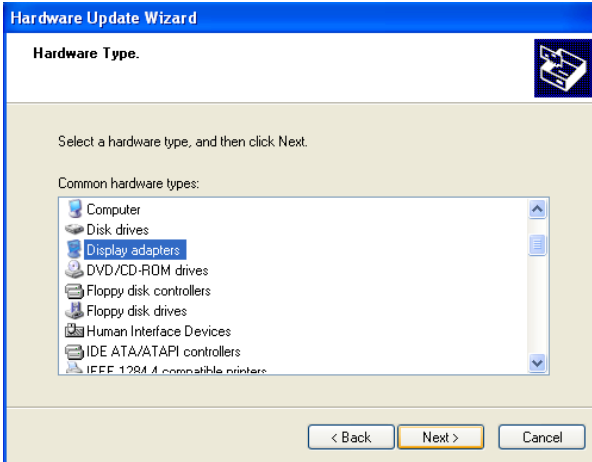

Step 8. Type the path D:\Biscuit\9575\VGA\WinXP then press “OK” button.

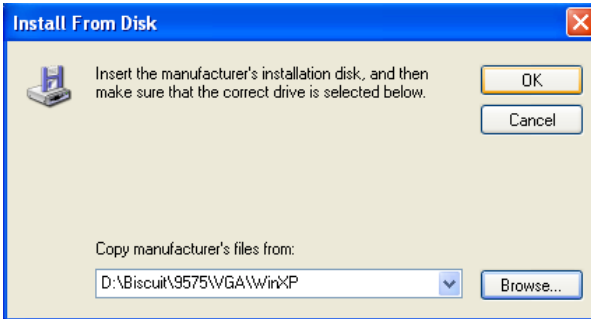

Step 9. Choose “S3 Graphics Twister + S3 Hotkey” then press “Next” button.

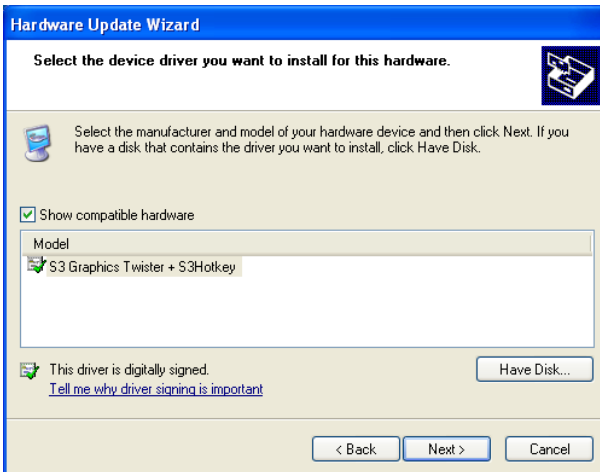

Step 10. Press “Finish” to reboot.

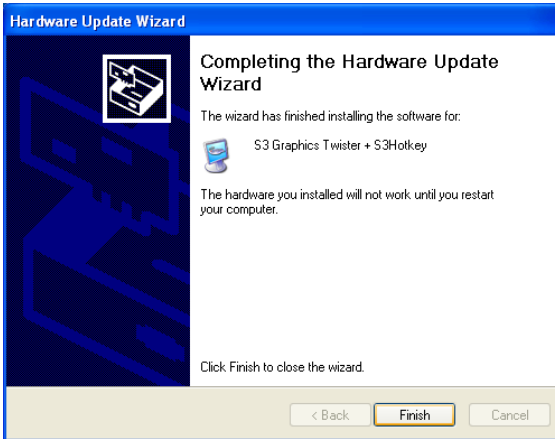

5.3 Further Information

For further information about the AGP/VGA installation in your PCM-9575, including driver updates, troubleshooting guides and FAQ lists, visit the following web resources:

VIA website: www.via.com.tw

CHAPTER 6

Audio Setup

The PCM-9575 is equipped with an audio interface that records and plays back CD-quality audio. This chapter provides instructions for installing the software drivers included on the audio driver diskettes.

Chapter 6 Audio Setup

6.1 Introduction

The PCM-9575's on-board audio interface provides high-quality stereo sound and FM music synthesis (ESFM) by using the VIA VT82C686 audio controller from VIA. The audio interface can record, compress, and play back voice, sound, and music with built-in mixer control.

The PCM-9575 on board audio interface also supports the Plug and Play (PnP) standard and provides PnP configuration for the audio, FM, and MPU-104 logical devices. It is compatible with Sound Blaster™; Sound Blaster Pro™ version 3.01, voice and music functions. The ESFM synthesizer is register compatible with the OPL3 and has extended capabilities.

6.2 DOS utilities

6.2.1 VIA Sound Blaster Pro compatible set up program

Please "Enable" the Sound Blaster setting in the BIOS before playing Sound Blaster compatible DOS games. To enable the settings in the BIOS:

INTEGRATED PERIPHERALS -> Onboard Legacy Audio
-> Sound Blaster (Disable -> Enable)

Chipset Feature Setup ->On Chip Sound (Disable-> Enable)

The Sound Blaster Pro compatible sound chip is integrated into the VIA PCI audio device in order to have Sound Blaster compatible DOS games running on the system.

If you want to play Sound Blaster compatible DOS games under the real mode MS-DOS or the "Restart in MS-DOS" from Win9x, then you should run this setup program to enable OPL3 MIDI music. Otherwise, the sound effects will be heard, but not the music. If you want to play legacy games in a Windows DOS Box, then you don't need to install this program.

6.2.2 VIA Sound Blaster Installation

Follow these steps to enable the Sound Blaster Pro compatible functions.

Step 1. Enable the Sound Blaster first on the BIOS setting of the "Onboard Legacy Audio" and "On-Chip Sound".

Step 2. Run the "Install.exe".

```
A:> INSTALL
```

Step 3. The program will copy the relative files into the directory which you assign. Next, the program will insert the following new line into the AUTOEXEC.BAT and copy the original AUTOEXEC.BAT to AUTOEXEC.VIA.

```
C: \VIAUDIO\VIAUDIO.COM
```

Step 4. Reboot the system when the installation is complete.

Step 5. Uninstall by deleting the new line from the AUTOEXEC.BAT.

6.3 Driver installation

6.3.1 Before you begin

Please read the instructions in this chapter carefully before you attempt installation. The audio drivers for the PCM-9575 board are located on the audio driver CD. Run the supplied SETUP program to install the drivers; don't copy the files manually.

Note: The files on the software installation diskette are compressed. Do not attempt to install the drivers by copying the files manually. You must use the supplied SETUP program to install the drivers.

6.3.2 Windows 95/98 drivers

Step 1. Click "Start" and select "Settings". Click "Control Panel" and double-click "Add New Hardware".



Step 2. In the Add New Hardware Wizard window, click "Next".



Step 3. In the following Add New Hardware Wizard window, click "Next" for Windows to search for Plug and Play devices.



Step 4. In the following Add New Hardware Wizard window, select "No, the device isn't in the list." and click "Next".



Step 5. In the following Add New Hardware Wizard window, select "No, I want to select..." and click "Next".



Step 6. In the following Add New Hardware Wizard window, select "Sound, video and game controllers" and click "Next".

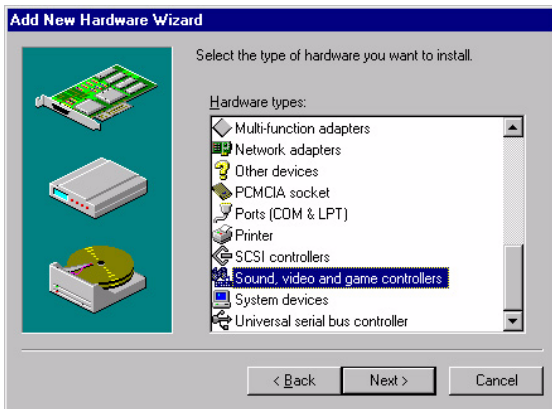

Step 7. In the following Add New Hardware Wizard window, click "Have Disk...".



Step 8. In the Install From Disk window, click "Browse".

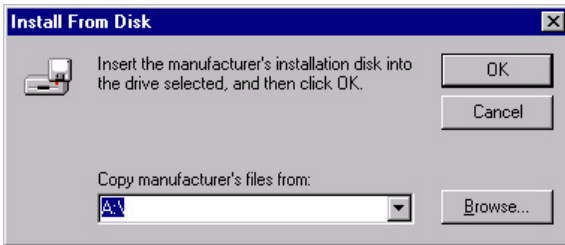

Step 9. In the Open window, select
"D:\Biscuit\9575\Audio\98se_Me_2k_xp\WIN95_98.

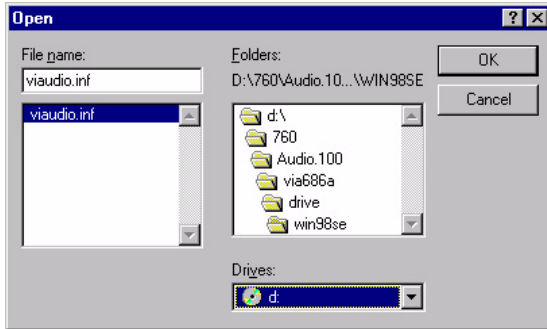

Step 10. In the Install From Disk window, click" OK".

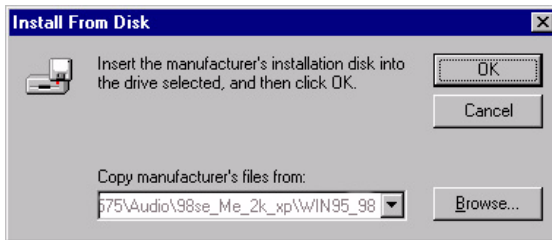

Step 11. In the Select Device window, select "VIA PCI Audio Controller (WDM)" and click "OK".

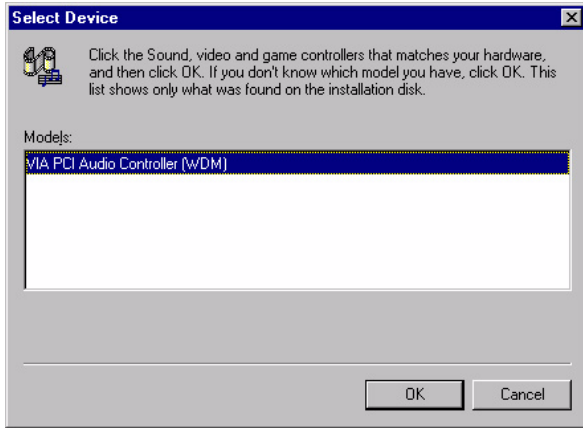

Step 12. In the Add New Hardware Wizard window, click "Next".



Step 13. The Copying Files... window will appear.

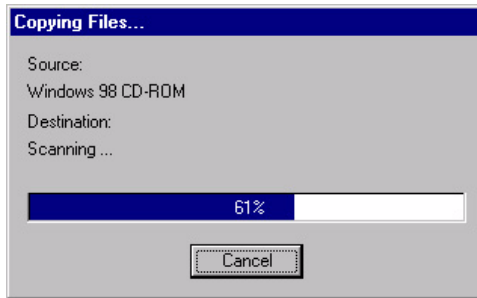

Step 14. In the Add New Hardware Wizard window, click "Finish". Then reboot the system.



6.3.3 Windows NT drivers

Step 1. Click "Start" and select "Settings". Click "Control Panel" and double-click "Multimedia".



Step 2. In the Multimedia Properties window, select the "Devices" tab. Then select the "Audio Devices" item, and click "Add...".

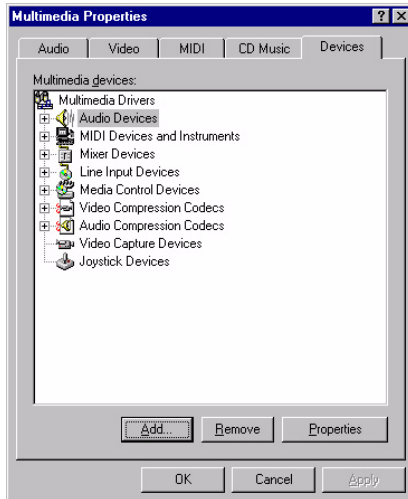

Step 3. In the Add window, select the "Unlisted..." item and click "OK".

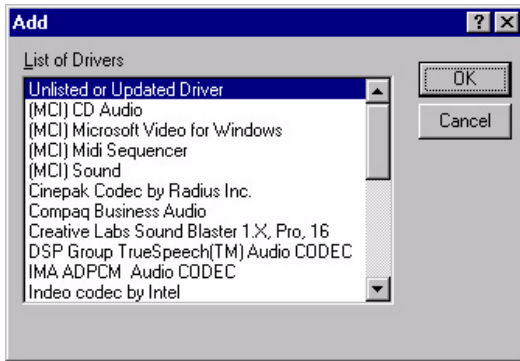

Step 4. When the Install Driver window appears, insert the utility disc into the CD-ROM drive. Type: D:\Biscuit\9575\Audio\WinNT\ Then click "OK".

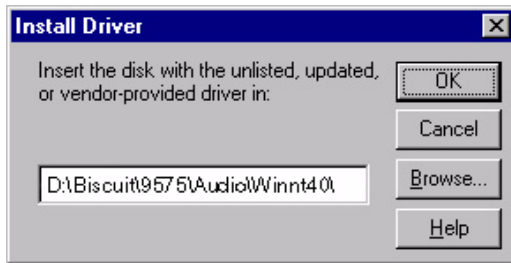

Step 5. In the Add Unlisted or Updated Driver window, select the "VIA PCI Audio controller" item. Then click "OK".

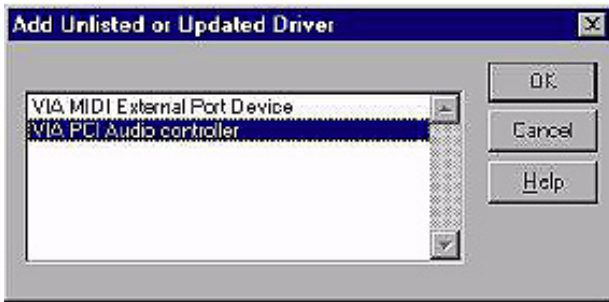

Step 6. In the System Setting Change window, click "Restart Now".



6.3.4 Windows 2000 Drivers

Step 1. Select “System”, “Setting”, “Control Panel” and double click “system” icon.

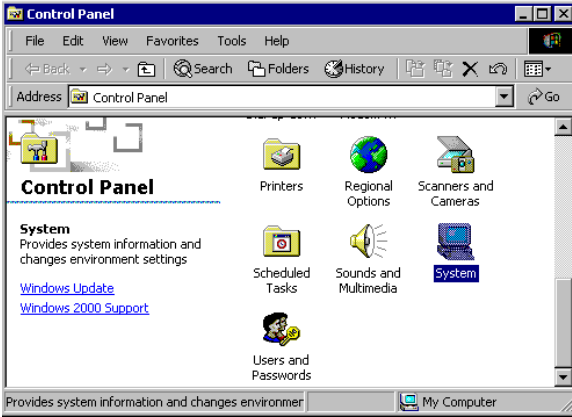

Step 2. Choose “Multimedia Audio Controller” button.

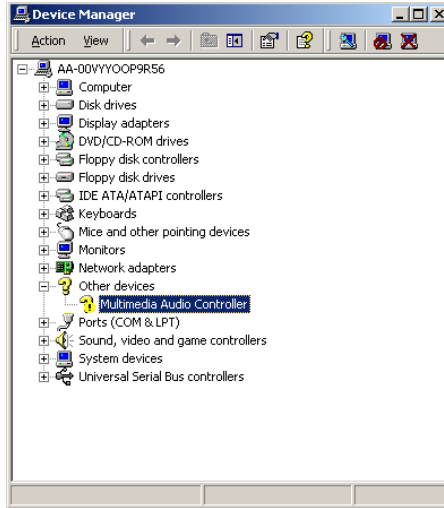

Step 3. Choose “Driver button, press “Update Driver” button.

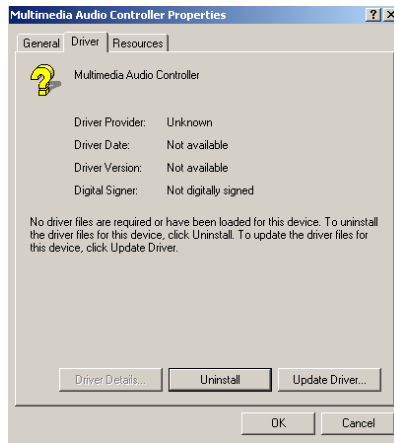

Step 4. Choose “Sound, video and game controllers”, press “Next”

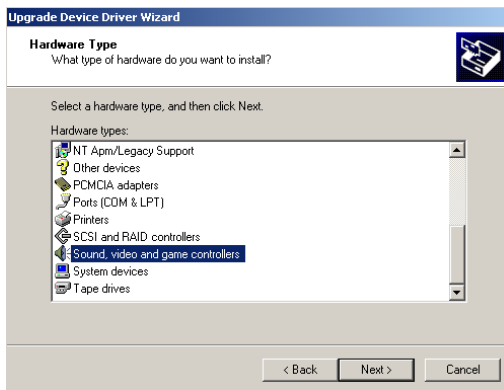

Step 5. Click the “Have Disk...” button

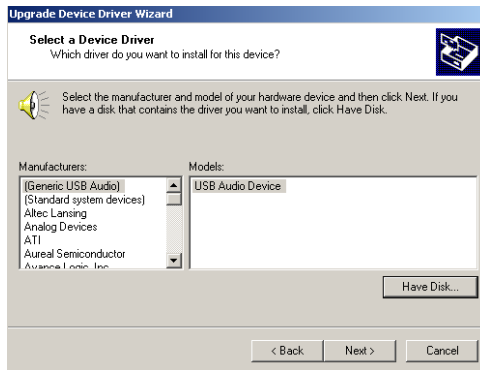

Step 6. Type the path D:\Biscuit\9575\Audio\98se_Me_2k_xp\Win2000 press the “ok” button.

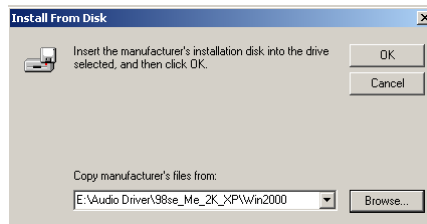

Step 7. Click “Have Disk” button

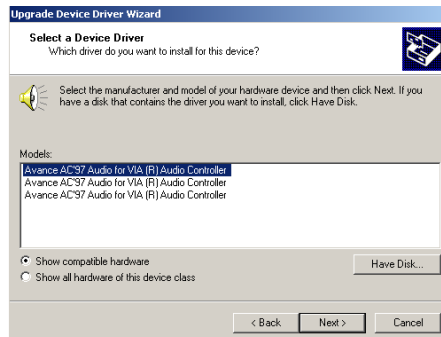

Step 8. Press “Next” button

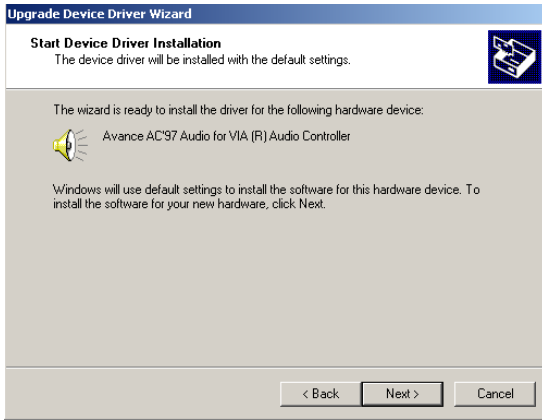

Step 9. Press “Finish” to reboot



PCI Bus Ethernet Interface

This chapter provides information on Ethernet configuration.

- Introduction
- Installation of Ethernet drivers for Windows 98/2000/NT
- Further information

Chapter 7 PCI Bus Ethernet Interface

7.1 Introduction

The PCM-9575 is equipped with a high performance 32-bit Ethernet chipset which is fully compliant with IEEE 802.3 100 Mbps CSMA/CD standards. It is supported by major network operating systems. It is also both 100Base-T and 10Base-T compatible. The medium type can be configured via the RSET8139.exe program included on the utility disk.

The Ethernet port provides a standard RJ-45 jack via an optional wiring kit. The network boot feature can be utilized by incorporating the boot ROM image files for the appropriate network operating system. The boot ROM BIOS files are combined with system BIOS, which can be enabled/disabled in the BIOS setup.

7.2 Installation of Ethernet driver

Before installing the Ethernet driver, note the procedures below. You must know which operating system you are using in your PCM-9575 Series, and then refer to the corresponding installation flow chart. Then just follow the steps described in the flow chart. You will quickly and successfully complete the installation, even if you are not familiar with instructions for MS-DOS or Windows.

Note: The windows illustrations in this chapter are examples only. Follow the steps and pay attention to the instructions which appear on your screen.

7.2.1 Installation for MS-DOS and Windows 3.1

If you want to set up your Ethernet connection under the MS-DOS or Windows 3.1 environment, you should first check your server system model. For example, MS-NT, IBM-LAN server, and so on.

Then choose the correct driver to install in your biscuit PC.

The installation procedures for various servers can be found on the supplied CD-ROM, the correct path being:

D:\Biscuit\9575\LAN\8139C\wfw311

7.2.2 Installation for Windows 98

- Step 1. a. Select "Start", "Settings", "Control Panel".
b. Double click "Network".



- Step 2. a. Click "Add" and prepare to install network functions.

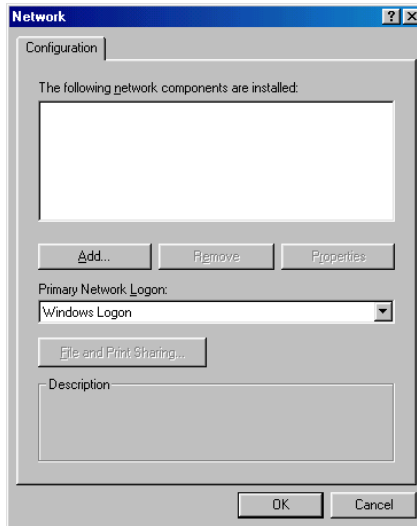

Step 3. a. Select the "Adapter" item to add the Ethernet card.

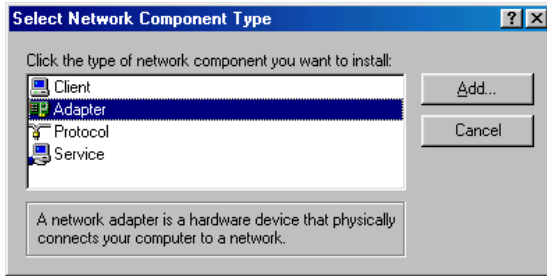

Step 4. a. Click "Have Disk" to install the driver.

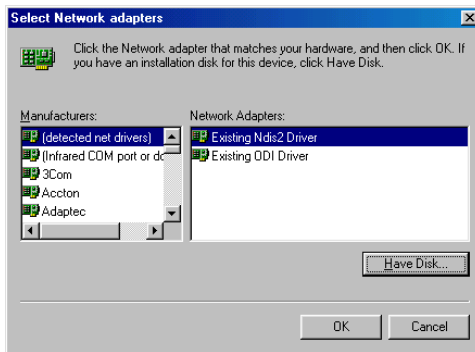

- Step 5. a. Insert the CD into the D: drive
- b. Fill in "D:\Biscuit\9575\LAN"
- c. Click "OK"

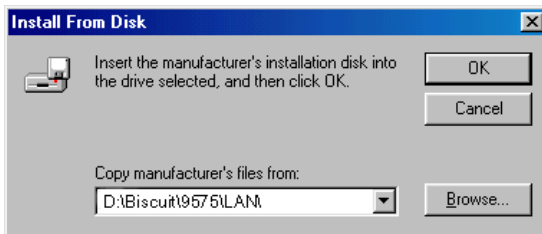

- Step 6. a. Choose the "Realtek RTL8139(A/B/C/8130) PCI Fast Ethernet" item.
b. Click "OK".

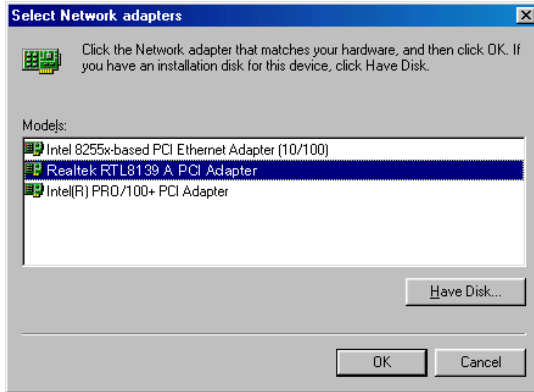

- Step 7. a. Make sure the configurations of relative items are set correctly.
b. Click "OK" to reboot.

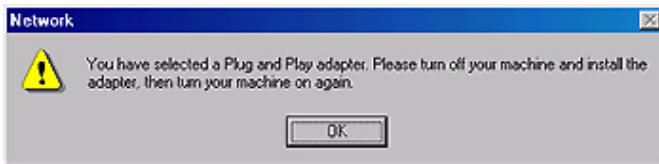

7.2.3 Installation for Windows 2000

Step 1. Open Device Manager,

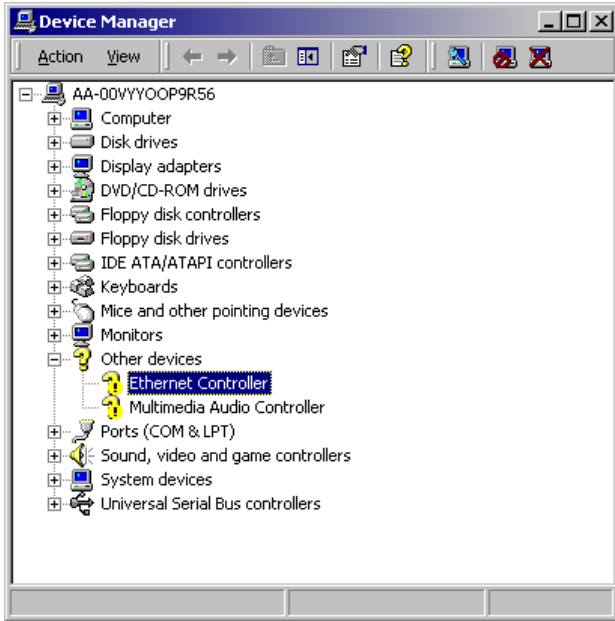

Step 2.

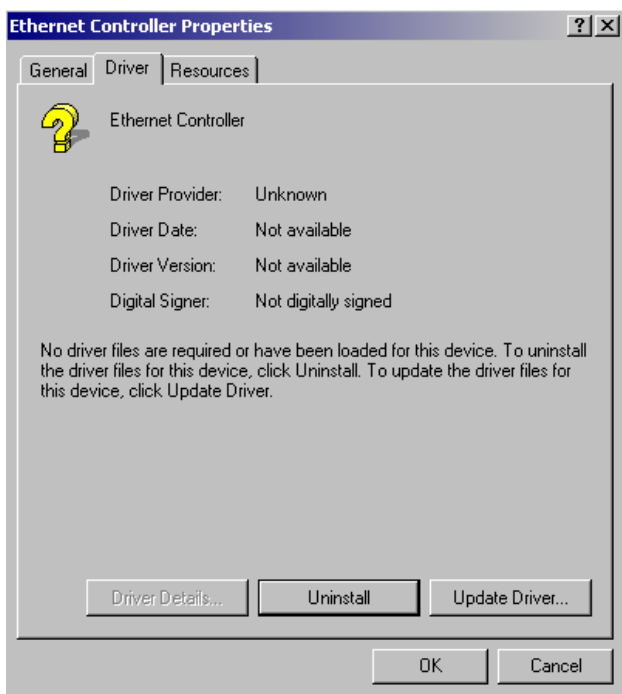

Step 3.

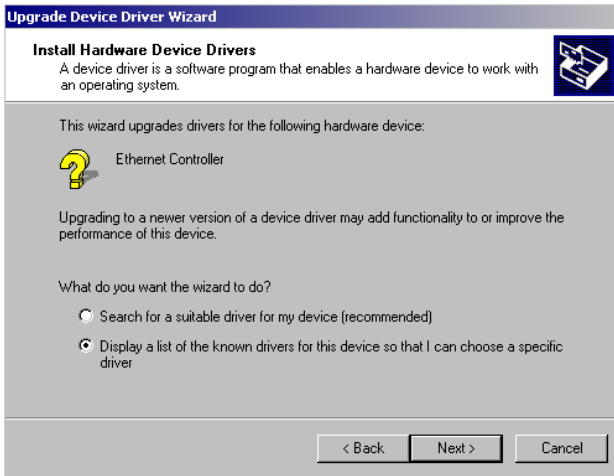

Step 4.



Step 5.

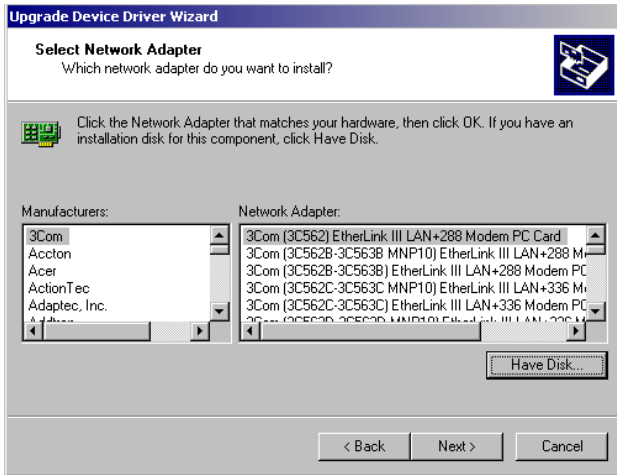

Step 6.

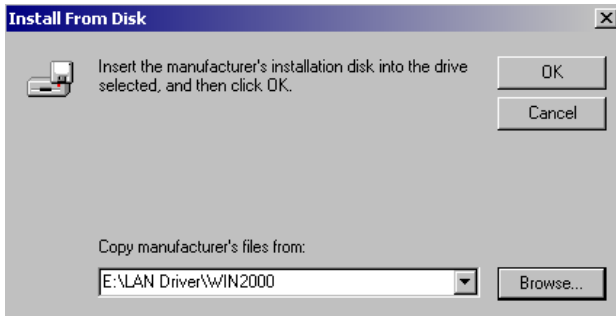

Step 7.

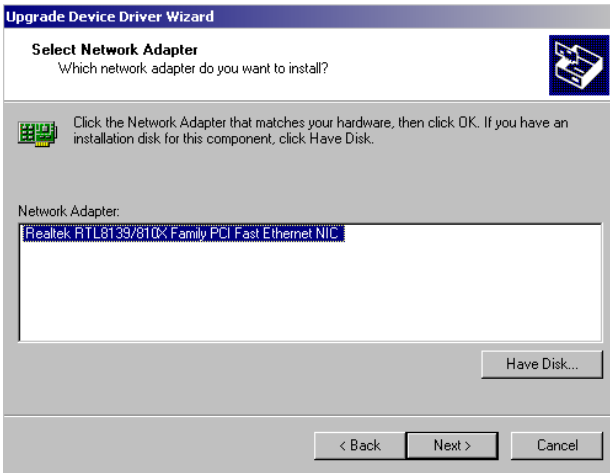

Step 8.



Step 9.

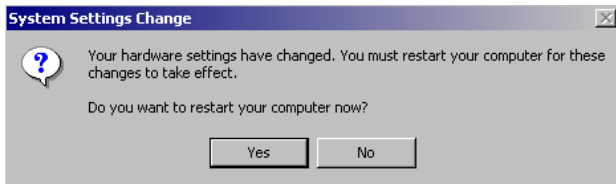

7.2.4 Installation for Windows NT

- Step 1. a. Select "Start", "Settings", "Control Panel"
b. Double click "Network"

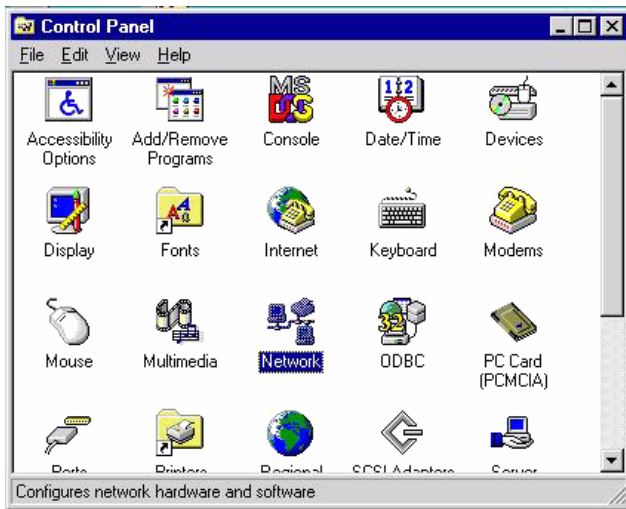

- Step 2. a. Choose type of network.

b. Click "Next"

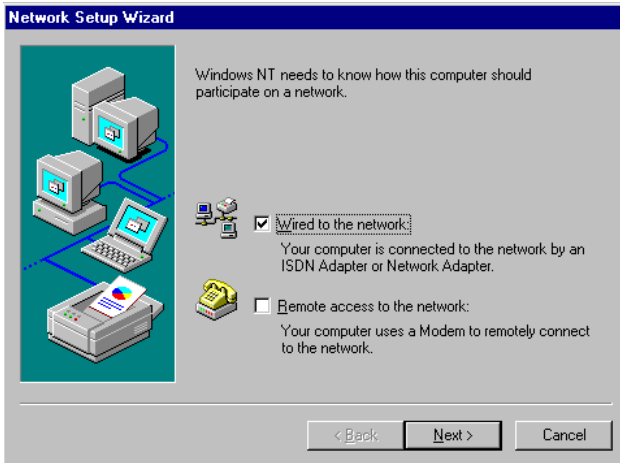

Step 3. a. Click "Select from list..."

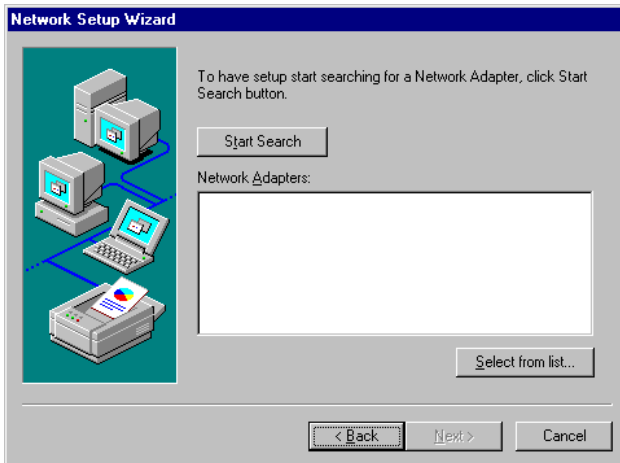

Step 4. Click “Have Disk.”

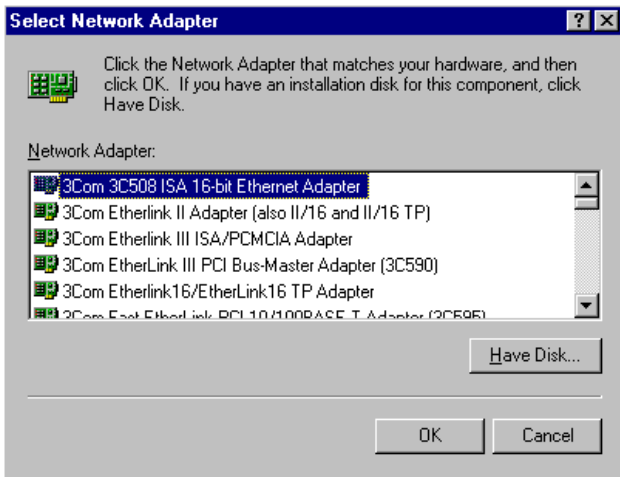

- Step 5. a. Insert the Utility CD ROM
b. Fill in the correct path:
D:\Biscuit\9575\LAN\8139C\winnt4
c. Click "OK".

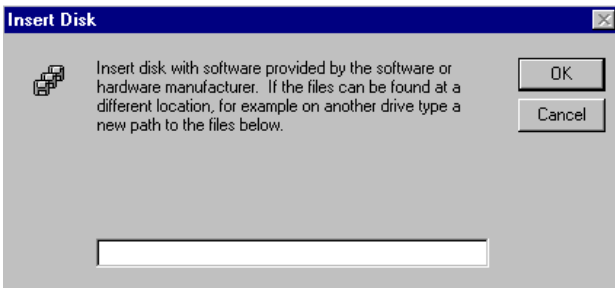

Step 6. Check the highlighted item, and click “OK.”

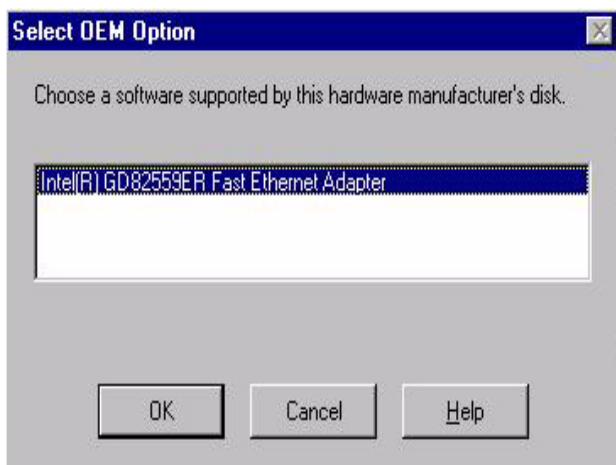

7. Click "Next" to continue setup.

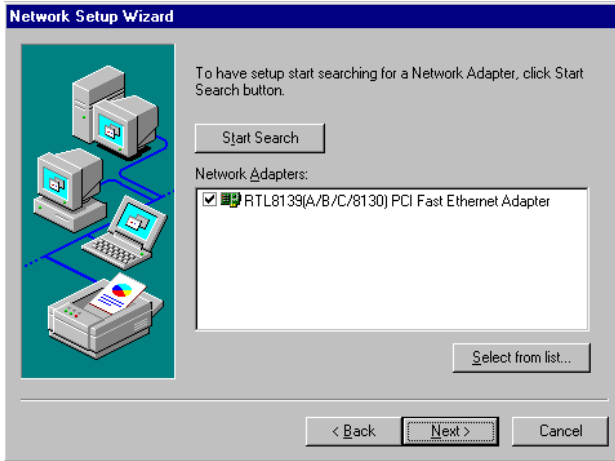

- Step 8. Choose the networking protocols, then click "Next"

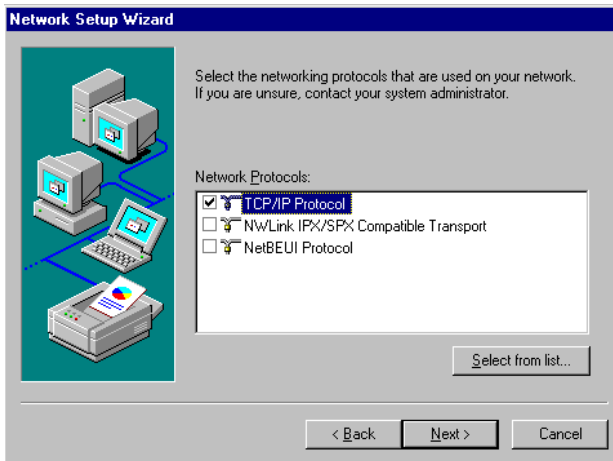

Step 9. Select the correct Network Services then click "Next"

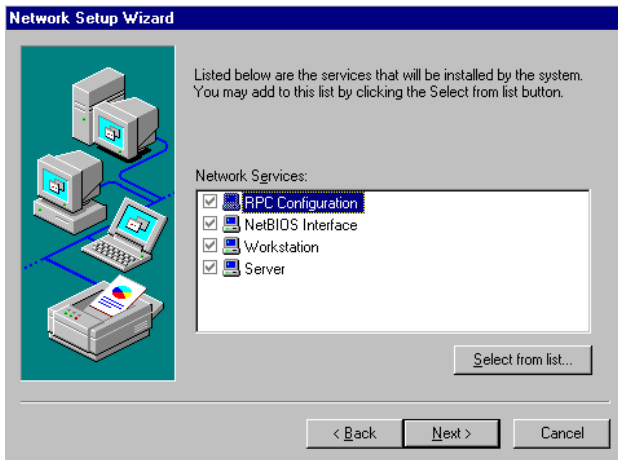

Step 10. Click "Next" to continue setup.

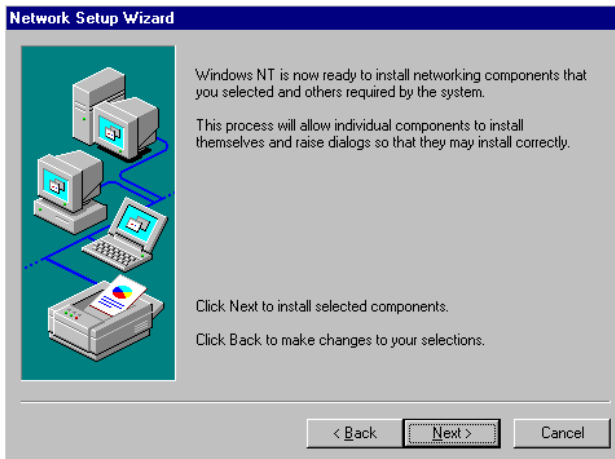

11. Click “Next” to start the network.

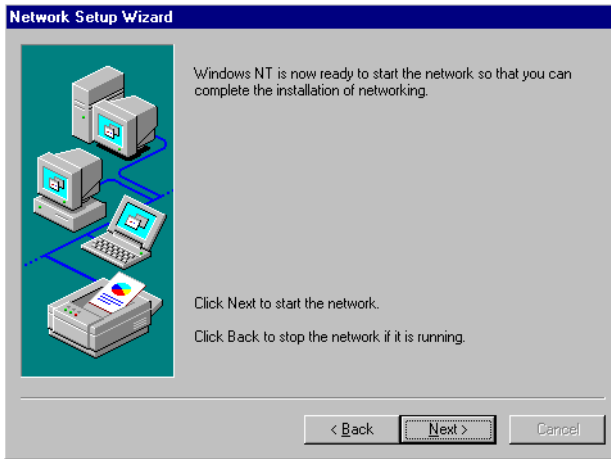

7.3 Further information

Realtek website: www.realtek.com.tw
Intel website: www.intel.com

Appendix A

Programming the Watchdog Timer

The PCM-9575 is equipped with a watchdog timer that resets the CPU or generates an interrupt if processing comes to a standstill for any reason. This feature ensures system reliability in industrial standalone or unmanned environments.

Appendix A Programming the Watchdog Timer

A.1 Supported Input Timing Modes

In order to program the watchdog timer, you must write a program which writes I/O port address 443 (hex). The output data is a value of time interval. The value range is from 01 (hex) to 3E (hex), and the related time interval is 1 sec. to 62 sec.

Data	Time Interval
01	1 sec.
02	2 sec.
03	3 sec.
04	4 sec.
	.
	.
	.
3E	62 sec.

After data entry, your program must refresh the watchdog timer by rewriting the I/O port 443 (hex) while simultaneously setting it. When you want to disable the watchdog timer, your program should read I/O port 443 (hex).

The following example shows how you might program the watchdog timer in BASIC:

```
10      REM Watchdog timer example program
20      OUT &H443, data  REM Start and restart the
      watchdog
30      GOSUB 1000  REM Your application task #1
40      OUT &H443, data  REM Reset the timer
50      GOSUB 2000  REM Your application task #2
60      OUT &H443, data  REM Reset the timer
70      X=INP (&H443)  REM Disable the watchdog timer
80      END

1000    REM  Subroutine #1, your application task
      .
      .
      .
1070    RETURN
2000    REM  Subroutine #2, your application task
      .
      .
      .
2090    RETURN
```

Appendix **B**

Installing PC/104-Plus Modules

This appendix gives instructions for installing PC/104- Plus modules.

Appendix B Installing PC/104-Plus Modules

B.1 Installing PC/104-Plus Modules

The PCM-9575's PC/104 connectors give you the flexibility to attach PC/104+ modules.

Installing these modules on the PCM-9575 is quick and simple. The following steps show to mount the PC/104+ modules:

1. Remove the PCM-9575 from your system, paying particular attention to the safety instructions already mentioned above.
2. Make any jumper or link changes required to the CPU card now. Once the PC/104+ module is mounted, you may have difficulty in accessing these.
3. Normal PC/104+ modules have male connectors and mount directly onto the main card. (Refer to the diagram on the following page.)
4. Mount the PC/104+ module onto the CPU card by pressing the module firmly but carefully onto the mounting connectors.
5. Secure the PC/104+ module onto the CPU card using the four mounting spacers and screws.

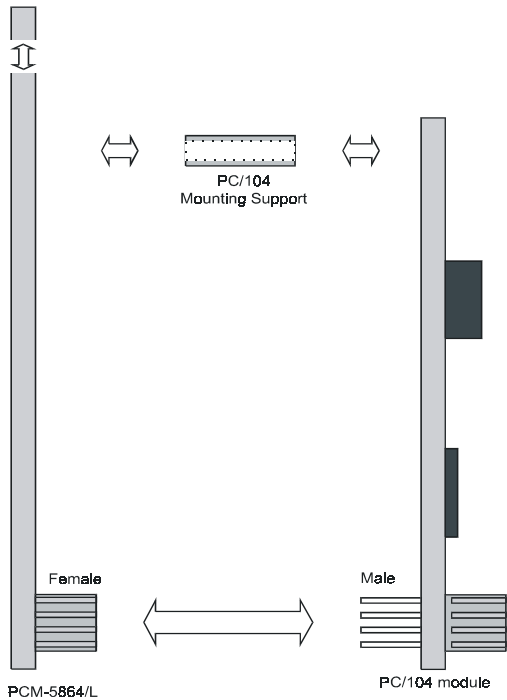

Figure B.1: PC/104+ module mounting diagram

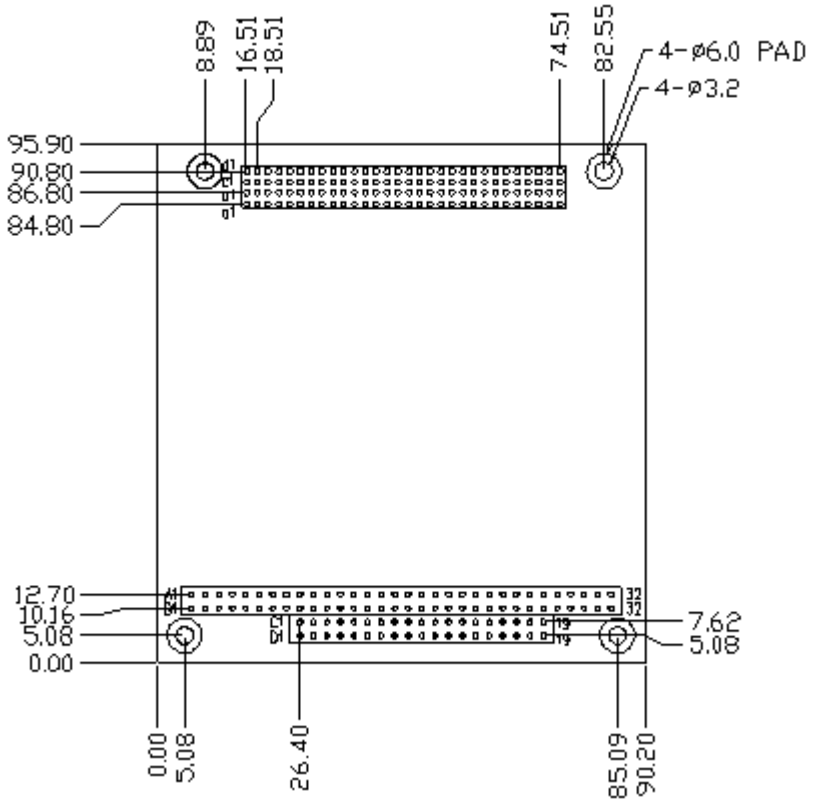

Figure B.2: PC/104+ module dimensions (mm) (± 0.1)

Pin Assignments

This appendix contains information of a detailed or specialized nature. It includes:

- CPU Fan Power Connector
- Ethernet 10/100Base-T Connector
- Audio Connector
- CD Drive Connector
- Main Power Connector
- Keyboard and PS/2 Mouse Connector
- Floppy Drive Connector
- PC/104 Connector
- IDE (1st and 2nd) HDD Connector
- Parallel Port Connector
- Power & HDD LED,
Reset Button Connector
- USB Connector
- Backlight Connector
- IR Connector
- CRT Display Connector
- TV-out Connector
- Flat Panel Connector
- Ext. Flat Panel Connector
- LCD Signal Mapping
- Peripheral power connector
- LVDS Interface Connector
- COM Port Connector
- CompactFlash Card Connector
- ATX Power Feature Connector

Appendix C Pin Assignments

C.1 CPU Fan Power Connector (FAN 1)



Table C.1: IR connector (FAN 1)

Pin	Signal
1	Fan speed signal input
2	+5V
3	GND

C.2 Ethernet 10/100Base-T Connector (CN12)

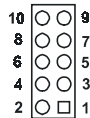

Table C.2: Ethernet 10/100Base-T connector (CN12)

Pin	Signal
1	VCC
2	CRS LED
3	RCV+
4	RCV-
5	BNC LED
6	GND
7	N/C
8	GND
9	XMT+
10	XMT-

C.3 Audio Connector (CN4)

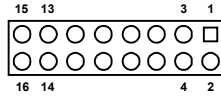

Table C.3: Audio connector (CN4)

Pin	Signal	Pin	Signal
1	SPEAKER OUT R+	2	SPEAKER OUT R-
3	SPEAKER OUT L+	4	SPEAKER OUT L-
5	LINE OUT R	6	LINE OUT L
7	GND	8	GND
9	LINE IN R	10	LINE IN L
11	GND	12	GND
13	NC	14	NC
15	MIC IN	16	GND

C.4 Audio In Connector (CN2)

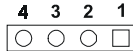

Table C.4: Audio line-in connector (CN2)

Pin	Signal
1	CD Audio R
2	GND
3	GND
4	CD Audio L

C.5 Main Power Connector (CN5)

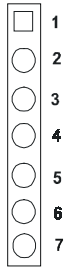

Table C.5: Main Power Connector (CN5)

Pin	Signal
1	+5 V
2	GND
3	GND
4	+12 V
5	N.C.
6	GND
7	+5 V

C.6 Keyboard and PS/2 Mouse Connector (CN25)

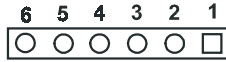

Table C.6: Keyboard and mouse connector (CN25)

Pin	Signal
1	KB CLOCK
2	KB DATA
3	MS CLOCK
4	GND
5	+5V (KB VCC)
6	MS DATA

C.7 Floppy Disk Drive Connector (CN18)

Table C.7: Floppy Disk Drive Connector (CN18)

Pin	Signal	Pin	Signal
1	GND	2	DENSITY SELECT*
3	GND	4	N/C
5	GND	6	DRIVE TYPE
7	GND	8	INDEX*
9	GND	10	MOTOR 0*
11	GND	12	DRIVE SELECT 1*
13	GND	14	DRIVE SELECT 0*
14	GND	16	MOTOR 1*
17	GND	18	DIRECTION*
19	GND	20	STEP*
21	GND	22	WRITE DATA*
23	GND	24	WRITE GATE*
25	GND	26	TRACK 0*
27	GND	28	WRITE PROTECT*
29	GND	30	READ DATA*
31	GND	32	HEAD SELECT*
33	GND	34	DISK CHANGE*

*low active

C.8 PC/104 plus Connectors (CN17)

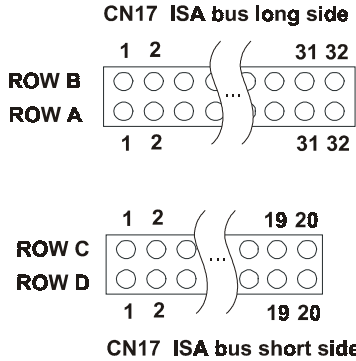

Table C.8: PC/104+ connectors (CN17)

Pin Number	Row A	Row B	Row C	Row D
1	IOCHCHK*	GND	GND	GND
2	SD7	RESET	SBHE*	MEMCS16*
3	SD6	+5 V	LA23	IOCS16*
4	SD5	IRQ9	LA22	IRQ10
5	SD4	-5V	LA21	IRQ11
6	SD3	DRQ2	LA20	IRQ12
7	SD2	-12V	LA19	IRQ15
8	SD1	ENDXFR*	LA18	IRQ14
9	SD0	+12V	LA17	DACKO*
10	IOCHRDY	(KEY)	MEMR*	DRQ0
11	AEN	SMEMW*	MEMW*	DACK5*
12	SA19	SMEMR*	SD8	DRQ5
13	SA18	IOW*	SD9	DACK6*
14	SA17	IOR*	SD10	DRQ6
15	SA16	DACK3*	SD11	DACK7*
16	SA15	DRQ3	SD12	DRQ7
17	SA14	DACK1*	SD13	+5V
18	SA13	DRQ1	SD14	MASTER*
19	SA12	REFRESH*	SD15	0V
20	SA11	SYSCLK	(KEY)	0V
21	SA10	IRQ7	----	----
22	SA9	IRQ6	----	----

Table C.8: PC/104+ connectors (CN17)

Pin Number	Row A	Row B	Row C	Row D
23	SA8	IRQ5	----	----
24	SA7	IRQ4	----	----
25	SA6	IRQ3	----	----
26	SA5	DACK2*	----	----
27	SA4	TC	----	----
28	SA3	BALE	----	----
29	SA2	+5V	----	----
30	SA1	OSC	----	----
31	SA0	0V	----	----
32	0V	0V	----	----

* low active

C.9 IDE Hard Drive Connector (CN14, CN16)

Table C.9: IDE HDD connector (CN14, CN16)

Pin	Signal	Pin	Signal
1	IDE RESET*	2	GND
3	DATA 7	4	DATA 8
5	DATA 6	6	DATA 9
7	DATA 5	8	DATA 10
9	DATA 4	10	DATA 11
11	DATA 3	12	DATA 12
13	DATA 2	14	DATA 13
15	DATA 1	16	DATA 14
17	DATA 0	18	DATA 15
19	SIGNAL GND	20	N/C
21	HDD 0	22	GND
23	IO WRITE	24	GND
25	IO READ	26	GND
27	HD READY	28	N/C
29	HDACK 0*	30	GND
31	IRQ14	32	N/C
33	ADDR 1	34	N/C
35	ADDR 0	36	ADDR 2
37	HARD DISK SELECT 0*	38	HARD DISK SELECT 1*
39	IDE ACTIVE*	40	GND
41	VCC	42	VCC
43	GND	44	N/C

* low active

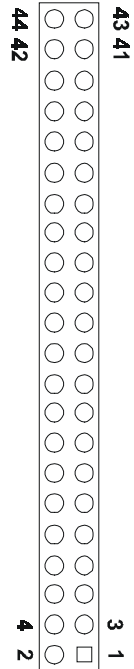

C.10 Parallel Port Connector (CN15)

Table C.10: Parallel Port Connector (CN15)

Pin	Signal	Pin	Signal
1	STROBE*	2	AUTOFD*
3	D0	4	ERR
5	D1	6	INIT*
7	D2	8	SLCTINI*
9	D3	10	GND
11	D4	12	GND
13	D5	14	GND
15	D6	16	GND
17	D7	18	GND
19	ACK*	20	GND
21	BUSY	22	GND
23	PE	24	GND
25	SLCT	26	N/C

* low active

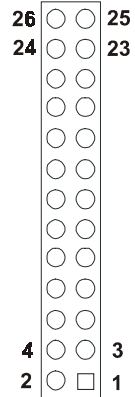

C.11 Power & HDD LED Connector(CN13)

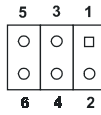

Table C.11: Power & HDD LED Connector (CN13)

Pin	Signal
1	+5V
2	GND
3	power LED+ (+5V)
4	HDD LED +
5	power LED - (GND)
6	HDD LED -

C.12 Reset Button Connector (CN22)



Table C.12: Reset Button Connector (CN22)

Pin	Signal
1	Reset signal input
2	GND

C.13 USB Connector (CN20, CN28)

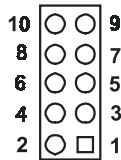

Table C.13: USB Connector (CN20, CN28)

Pin	Signal	Pin	Signal
1	+5 V	2	+5 V
3	UV-	4	UV-
5	UV+	6	UV+
7	GND	8	GND
9	Chassis GND	10	N/C

C.14 LCD Inverter Backlight Connector (CN6)

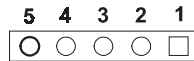

Table C.14: LCD Inverter Backlight Connector (CN6)

Pin	Signal
1	+12 V
2	GND
3	ENABKL
4	VBR
5	+5 V

C.15 IR Connector (CN24)

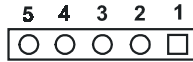

Table C.15: IR Connector (CN24)

Pin	Signal
1	VCC (5 V)
2	N.C.
3	IR receive
4	GND
5	IR transmit

C.16 CRT Display Connector (CN8)

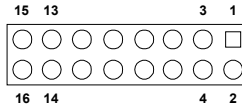

Table C.16: CRT Display Connector (CN8)

Pin	Signal	Pin	Signal
1	RED	9	VGA G
2	+5 V	10	H-sync signal
3	GREEN	11	VGA G
4	VGA G	12	V-sync signal
5	BLUE	13	VGA G
6	N/C	14	VGA CK
7	N/C	15	VGA G
8	VGA Data	16	N/C

C.17 TV (video) Out Connector (CN1)

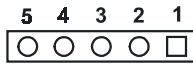

Table C.17: TV (video) Out Connector (CN1)

Pin	Signal
1	Luminance out (S-Video Y output, brightness)
2	Chrominance out (S-Video C output, color)
3	GND
4	GND
5	Composite video out

C.18 Flat Panel Connector (CN11)

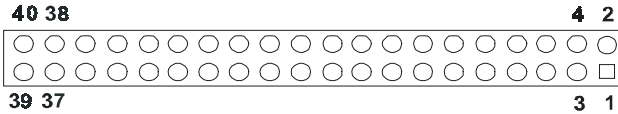

Table C.18: Flat Panel Connector (CN11)

Pin	Signal	Pin	Signal
1	VDDSAFE5 (+5v output)	2	VDDSAFE5 (+5v output)
3	GND	4	GND
5	VDDSAFE3 (+3.3 v output)	6	VDDSAFE3 (+3.3 v output)
7	N/C	8	GND
9	P0	10	P1
11	P2	12	P3
13	P4	14	P5
15	P6	16	P7
17	P8	18	P9
19	P10	20	P11
21	P12	22	P13
23	P14	24	P15
25	P16	26	P17
27	P18	28	P19
29	P20	30	P21
31	P22	32	P23
33	GND	34	GND
35	SHFCLK	36	FLM
37	M/DE	38	LP
39	N/C	40	ENAVEE

Note: *The model number of the CN11 socket is DF13A-40DP-1.25V (Hirose Electric Co., Ltd.)*

C.19 Extended Flat Panel Display Connector (CN10)

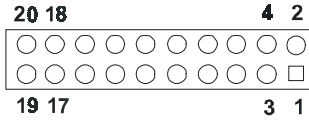

Table C.19: Extended Flat Panel Display Connector (CN10)

Pin	Signal	Pin	Signal
1	GND	2	GND
3	P24	4	P25
5	P26	6	P27
7	P28	8	P29
9	P30	10	P31
11	P32	12	P33
13	P34	14	P35
15	GND	16	GND
17	N/C	18	N/C
19	N/C	20	N/C

Note: *The model number of the CN10 socket is DF13A-20DP-1.25V (Hirose Electric Co., Ltd.)*

C.20 LCD Signal Mapping

Table C.20: LCD Signal Mapping					
Pin Name	16-bit DSTN	24-bit DSTN	18-bit TFT	24-bit TFT	36-bit TFT
PD0		LB3		B0	R00
PD1		LB2		B1	R10
PD2	LB1	LB1	B0	B2	R01
PD3	LB0	LB0	B1	B3	R11
PD4		UB3	B2	B4	R02
PD5		UB2	B3	B5	R12
PD6	UB1	UB1	B4	B6	R03
PD7	UB0	UB0	B5	B7	R13
PD8		LG3		G0	R04
PD9	LG2	LG2		G1	R14
PD10	LG1	LG1	G0	G2	R05
PD11	LG0	LG0	G1	G3	R15
PD12		UG3	G2	G4	G00
PD13	UG2	UG2	G3	G5	G10
PD14	UG1	UG1	G4	G6	G01
PD15	UG0	UG0	G5	G7	G11
PD16		LR3		R0	G02
PD17	LR2	LR2		R1	G12
PD18	LR1	LR1	R0	R2	G03
PD19	LR0	LR0	R1	R3	G13
PD20		UR3	R2	R4	G04
PD21	UR2	UR2	R3	R5	G14
PD22	UR1	UR1	R4	R6	G05
PD23	UR0	UR0	R5	R7	G15
PD24					B00
PD25					B10
PD26					B01
PD27					B11
PD28					B02
PD29					B12
PD30					B03
PD31					B13
PD32					B04
PD33					B14
PD34					B05
PD35					B15

C.21 LVDS Connector (CN9)

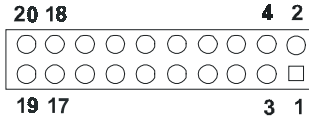

Table C.21: LVDS Connector (CN9)

Pin	Signal	Pin	Signal
1	GND	2	GND
3	TX0+(Channel 1)	4	TX0+(Channel 2)
5	TX0-(Channel 1)	6	TX0-(Channel 2)
7	TX1+(Channel 1)	8	TX1+(Channel 2)
9	TX1-(Channel 1)	10	TX1-(Channel 2)
11	TX2+(Channel 1)	12	TX2+(Channel 2)
13	TX2-(Channel 1)	14	TX2-(Channel 2)
15	TX3+(Channel 1)	16	TX3+(Channel 2)
17	TX3-(Channel 1)	18	TX3-(Channel 2)
19	VDD (+3.3V)	20	VDD (+3.3V)

C.22 Peripheral Power Connector (CN27)



Table C.22: Peripheral Power Connector (CN27)

Pin	Signal
1	-5 V
2	GND
3	-12 V

C.23 COM Port Connector (CN19)

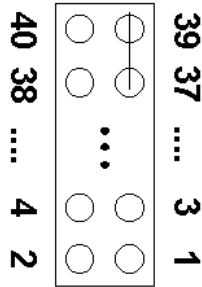

Table C.23: COM Port Connector (CN19)

Pin	Signal	Pin	Signal
1	RLSD1 (DCD1)	2	DSR1
3	RX1	4	RTS1
5	TX1	6	CTS1
7	DTR1	8	RI1
9	GND	10	GND
11	RLSD2 (DCD2)	12	DSR2
13	RX2	14	RTS2
15	TX2	16	CTS2
17	DTR2	18	RI2
19	GND	20	NC
21	RLSD3 (DCD3)	22	DSR3
23	RX3	24	RTS3
25	TX3	26	CTS3
27	DTR3	28	RI3
29	GND	30	NC
31	RLSD4 (DCD4)	32	DSR4
33	RX4	34	RTS4
35	TX4	36	CTS4
37	DTR4	38	RI4
39	GND	40	NC

C.24 CompactFlash Card Connector (CN26)

Pin	Signal	Pin	Signal
1	GND	2	D03
3	D04	4	D05
5	D06	6	D07
7	*CS0	8	A10
9	*ATA SEL	10	A09
11	A08	12	A07
13	+5 V	14	A06
15	A05	16	A04
17	A03	18	A02
19	A01	20	A00
21	D00	22	D01
23	D02	24	-IOCS16
25	*CD2	26	-CD1
27	D11	28	D12
29	D13	30	D14
31	D15	32	-CS1
33	*VS1	34	-IORD
35	*IOWR	36	-WE
37	INTRQ	38	+5 V
39	*CSEL	40	-VS2
41	*RESER	42	IORDY
43	*INPACK	44	-REG
45	*DASP	46	-PDIAG
47	D08	48	D09
49	D10	50	GND

* low active

C.25 ATX Power Feature Connector (CN3)



Table C.25: ATX Power Feature Connector (CN3)

Pin	Signal
1	5VSB (Stand by voltage)
2	GND
3	PS. ON#

Appendix **D**

System Assignments

This appendix contains information of a detailed nature. It includes:

- System I/O ports
- 1st MB memory map
- DMA channel assignments
- Interrupt assignments

Appendix D System Assignments

D.1 System I/O Ports

Addr. range (Hex)	Device
000-01F	DMA controller
020-021	Interrupt controller 1, master
040-05F	8254 timer
060-06F	8042 (keyboard controller)
070-07F	Real-time clock, non-maskable interrupt (NMI) mask
080-09F	DMA page register
0A0-0BF	Interrupt controller 2
0C0-0DF	DMA controller
0F0	Clear math co-processor
0F1	Reset math co-processor
0F8-0FF	Math co-processor
1F0-1F8	Fixed disk
200-207	Reserved (Game I/O)
278-27F	Parallel printer port 2 (LPT 3)
2E8-2EF	Series port 4
2F8-2FF	Serial port 2
300-31F	Prototype card
360-36F	Reserved
378-37F	Parallel printer port 1 (LPT 2)
380-38F	SDLC, bisynchronous 2
3A0-3AF	Bisynchronous 1
3B0-3BF	Monochrome display and printer adapter (LPT1)
3C0-3CF	Reserved
3D0-3DF	Color/graphics monitor adapter
3E8-3EF	Series port 3
3F0-3F7	Diskette controller
3F8-3FF	Serial port 1

* PNP audio I/O map range from 220 ~ 250H (16 bytes)
MPU-401 select from 300 ~ 330H (2 bytes)

D.2 1st MB memory map

Table D.2: 1st MB memory map

Addr. range (Hex)	Device
F0000h - FFFFFh	System ROM
*CC000h - EFFFFh	Unused (reserved for Ethernet ROM)
C0000h - CBFFFh	Expansion ROM (for VGA BIOS)
B8000h - BFFFFh	CGA/EGA/VGA text
B0000h - B7FFFh	Unused
A0000h - AFFFFh	EGA/VGA graphics
00000h - 9FFFFh	Base memory

* If Ethernet boot ROM is disabled (Ethernet ROM occupies about 16 KB)

* E0000 - EFFFF is reserved for BIOS POST

D.3 DMA channel assignments

Table D.3: DMA channel assignments

Channel	Function
0	Available
1	Available (audio)
2	Floppy disk (8-bit transfer)
3	Available (parallel port)
4	Cascade for DMA controller 1
5	Available
6	Available
7	Available

* Audio DMA select 1, 3, or 5

** Parallel port DMA select 1 (LPT2) or 3 (LPT1)

D.4 Interrupt assignments

Interrupt#	Interrupt source
IRQ 0	Interval timer
IRQ 1	Keyboard
IRQ 2	Interrupt from controller 2 (cascade)
IRQ 3	COM2
IRQ 4	COM1
IRQ 5	COM4
IRQ 6	FDD
IRQ 7	LPT1
IRQ 8	RTC
IRQ 9	Reserved (audio)
IRQ 10	COM3
IRQ 11	Reserved for watchdog timer
IRQ 12	PS/2 mouse
IRQ 13	INT from co-processor
IRQ 14	Primary IDE
IRQ 15	Secondary IDE for CFC

* Ethernet interface IRQ select: 9, 11, 15

* PNP audio IRQ select: 9, 11, 15

* PNP USB IRQ select: 9, 11, 15

* PNP ACPI IRQ select: 9, 11, 15

Appendix **E**

**Optional Extras for the
PCM-9575**

E.1 PCM-10586-5A00 cable kit for PCM-9575

The PCM-9575 requires several cables for normal operation. You can make them yourself or purchase an optional cable kit assembly, which includes the following:

PCM-10586-5V00 cable kit for PCM-9575			
Part No.	Cable Description	PCM-9575 Connector	Terminating Connector
1701440350	2.5" and 1.8" IDE	CN14	44-pin, 2 mm, female IDC (350 mm)
1701440452	3.5" IDE DMA/66 (40 pin)	CN16	40-pin, 2.54 mm, female IDC(450 mm)
1701340603	Dual Floppy, 3.5" and 5.25" (34p)	CN18	34-pin Dual Floppy
1701260250	Parallel Port	CN25	25-pin female DSUB
1701100202	Network, 10-Base-T	CN12	RJ45 8-pin modular jack
1701160101	VGA CRT	CN1	2 x 8 pin header (2 mm) 15-pin DSUB
1700000190	Keyboard and PS/2 mouse	CN25	5-pin circular DIN, 6-pin circular DIN
1703030300	Peripheral power (-5V and -12V)	CN27	(3-conductor)
1701400181	COM 1 - 4 cable	CN19	40-pin, 9-pin male DSUB x4
1700160160	Audio Cable	CN4	F3.5mm 16-pin, five female phone jacks

E.2 Optional LCD cables 10.4" TFT LCD panel (CN14)

Table E.1: Optional LCD cables 10.4" TFT LCD panel

Part no.	Cable description	Panel type
1700090501	Cable DF9 (2 mm) 50 cm	Toshiba LTM10C042
1703440151	Wire 30P/44P 15 cm	Toshiba LTM12C275A

Note: The above LCD cables have links via 24-bit LCD cable adaptor (E.6) to connect to PCM-9575

E.3 Optional USB cable (CN20)

Optional USB cable (2-channel) Part no: 1703100261

Optional USB Cable for MBPC-300 Part no. 1703100121

E.4 ATX Power Control Cable (CN3)

part no.:1703200100

E.5 Optional PC/104+ to PCI Module

PCM-200-00A2 PC/104+ to PCI Module

E.6 Optional 24 bit LCD cable adaptor

This converts the Hirose “DF20A” type connector to a 20 x 2- pin header. It supports 3.3 V or 5 V via pins 5 and 6.

part no: 9681000041 (for 5 V LCD panel)

part no: 9681000040 (for 3.3 V LCD panel)

Appendix **F**

Mechanical Drawings

F.1 Mechanical Drawings

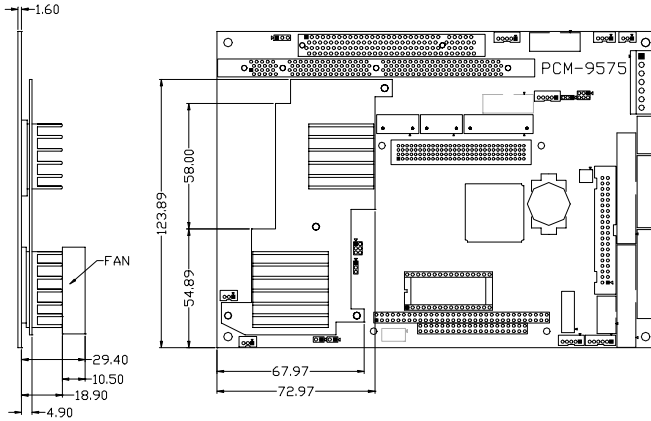

***Figure F.1: PCM-9575 Mechanical Drawing
(Side view for PCM-9575F-Q0A1 (w/ fan) and
PCM-9575F-M0A1(w/o fan) only)***

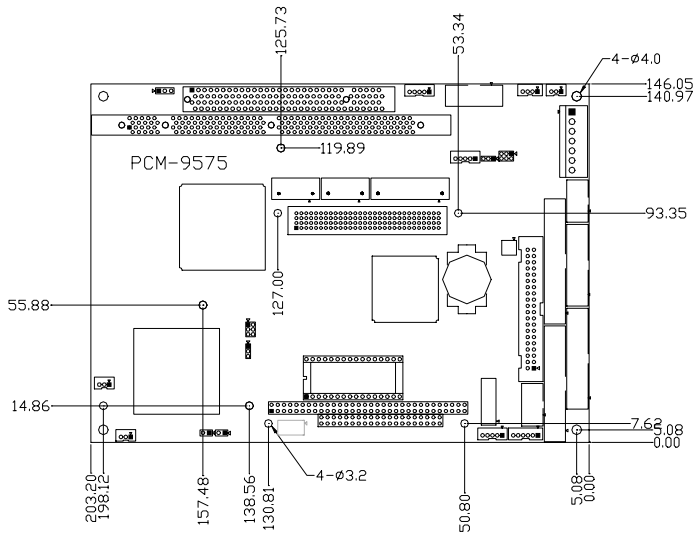

Figure F.2: PCM-9575 Mechanical Drawing (component side)

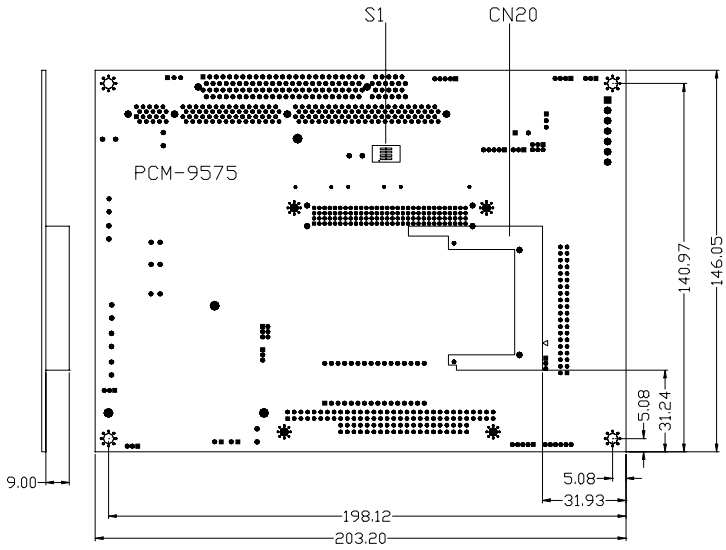

Figure F.3: PCM-9575 Mechanical Drawing (solder side)