

# **PCM-4335**

All-in-one 486DX-66  
with Flat Panel/CRT  
PC/104 Module

## **FCC STATEMENT**

THIS DEVICE COMPLIES WITH PART 15 FCC RULES. OPERATION IS SUBJECT TO THE FOLLOWING TWO CONDITIONS: (1) THIS DEVICE MAY NOT CAUSE HARMFUL INTERFERENCE. (2) THIS DEVICE MUST ACCEPT ANY INTERFERENCE RECEIVED INCLUDING INTERFERENCE THAT MAY CAUSE UNDESIREED OPERATION.

THIS EQUIPMENT HAS BEEN TESTED AND FOUND TO COMPLY WITH THE LIMITS FOR A CLASS "A" DIGITAL DEVICE, PURSUANT TO PART 15 OF THE FCC RULES. THESE LIMITS ARE DESIGNED TO PROVIDE REASONABLE PROTECTION AGAINTST HARMFUL INTERFERENCE WHEN THE EQUIPMENT IS OPERATED IN A COMMERCIAL ENVIRONMENT. THIS EQUIPMENT GENERATES, USES, AND CAN RADIATE RADIO FREQUENCY ENERGY AND, IF NOT INSTALLED AND USED IN ACCORDANCE WITH THE INSTRUCTION MANUAL, MAY CAUSE HARMFUL INTERFERENCE TO RADIO COMMUNICATIONS. OPERATION OF THIS EQUIPMENT IN A RESIDENTIAL AREA IS LIKELY TO CAUSE HARMFUL INTERFERENCE IN WHICH CASE THE USER WILL BE REQUIRED TO CORRECT THE INTERFERENCE AT HIS OWN EXPENSE.

## **Copyright Notice**

This document is copyrighted, 1997, 1998, by AAEON Technology Inc. All rights are reserved. AAEON Technology Inc. reserves the right to make improvements to the products described in this manual at any time without notice.

No part of this manual may be reproduced, copied, translated or transmitted in any form or by any means without the prior written permission of AAEON Technology Inc. Information provided in this manual is intended to be accurate and reliable. However, AAEON Technology Inc. assumes no responsibility for its use, nor for any infringements upon the rights of third parties which may result from its use.

## **Acknowledgements**

ALI is a trademark of Acer Laboratories, Inc.

AMI is a trademark of American Megatrends, Inc.

Cyrix is a trademark of Cyrix Corporation.

IBM, PC/AT, PS/2 and VGA are trademarks of International Business Machines Corporation.

Intel and Pentium are trademarks of Intel Corporation.

Microsoft Windows® and MS-DOS are registered trademarks of Microsoft Corp.

C&T is a trademark of Chips and Technologies, Inc.

## Packing list

---

Before you begin installing your card, please make sure that the following materials have been shipped:

- 1 Supporting CD-ROM
- 1 PCM-4335 CPU card
- 1 Quick Installation Guide
- 1 6-pin mini(crimp) dual outlet adapter for keyboard and PS/2 mouse
- 1 Hard disk drive (IDE) interface cable (40 pin)
- 1 Floppy disk drive interface cable (34 pin)
- PC/104 module mounting supports
- 1 SVGA adapter (16 pin)
- 1 parallel port adapter (26-pin and COM2 adapter (for RS-232/422/485) kit)
- 1 Serial port adapter (10-pin)

If any of these items are missing or damaged, contact your distributor or sales representative immediately.

## Notice

---

Dear Customer,

Thank you for purchasing the SBC-456/456E board. The user manual is designed to help you to get the most out of the SBC-456/456E, please read it thoroughly before you install and use the board. The product that you have purchased comes with two-year limited warranty, but AAEON cannot be responsible for misuse of the product. Therefore, we strongly urge you first read the manual before using the product.

To receive the latest version of the user manual, please visit our Web site at:

**<http://www.aaeon.com.tw>**

# Contents

<b>1</b>	<b>General Information.....</b>	<b>1</b>
	Introduction .....	2
	Specifications .....	3
<b>2</b>	<b>Installation .....</b>	<b>5</b>
	Jumpers and connectors .....	6
	Locating jumpers and connector .....	7
	Setting jumpers .....	8
	Safety precautions .....	9
	Fan power connector .....	10
	Floppy drive connector (CN2) .....	10
	Serial ports connector (CN3/COM1, CN8/COM2).....	12
	IDE hard drive connector (CN4) .....	14
	Connecting the hard drive .....	14
	Parallel port connector (CN5) .....	16
	Display connector (CN6, CN7) .....	17
	VGA display connector (CN6) .....	17
	LCD panel connector (CN7) .....	19
	Keyboard and PS/2 muse connector (CN9) .....	20
	Power supply connector (CN10) .....	21
	Exter power supply connector (J1) .....	22
	DOC address select (JP1) .....	23
	RS-232/422/485 select (JP2) .....	24
	Clear CMOS (JP3) .....	25
	Keyboard lock function(JP4).....	26
	LCD driving voltage select (JP5).....	27
	Reset switch (JP6) .....	28
	LCD signal select (JP7) .....	29
	External speaker connector (SP1) .....	30

<b>3</b>	<b>AMIBIOS Setup .....</b>	<b>31</b>
	<b>General information .....</b>	<b>32</b>
	Starting AMIBIOS setup .....	32
	AMIBIOS main menu .....	32
	Using a mouse with AMIBIOS setup .....	33
	Using the keyboard with AMIBIOS setup .....	33
	<b>Standard CMOS setup .....</b>	<b>34</b>
	<b>Advanced CMOS setup .....</b>	<b>36</b>
	<b>Advanced chipset setup .....</b>	<b>42</b>
	<b>Power management setup .....</b>	<b>43</b>
	<b>PCI/PLUG and play setup .....</b>	<b>46</b>
	<b>Peripheral setup .....</b>	<b>49</b>
	<b>Change supervisor password .....</b>	<b>51</b>
	<b>Auto configuration with optimal settings.....</b>	<b>52</b>
	<b>Auto configuration with fail safe settings .....</b>	<b>53</b>
	<b>Save settings and exit.....</b>	<b>54</b>
	<b>Exit without saving .....</b>	<b>55</b>
<b>4</b>	<b>Flat Panel/CRT Controller Display Drivers and Utilities .....</b>	<b>57</b>
	<b>Software drivers .....</b>	<b>58</b>
	Hardware configuration .....	58
	Necessary prerequisites .....	59
	Before you begin .....	59
	<b>Windows 95 .....</b>	<b>60</b>
	Driver installation .....	60
	<b>Windows 3.1 .....</b>	<b>68</b>
	Driver installation .....	68
	<b>OS/2 .....</b>	<b>69</b>
	<b>Windows NT 3.51 .....</b>	<b>71</b>
	Driver installation .....	71
	Windows NT 4.0 .....	72

<b>A</b>	<b>Watchdog Timer .....</b>	<b>73</b>
	<b>Watchdog Timer .....</b>	<b>73</b>
	<b>Example .....</b>	<b>75</b>
	<b>SetWatchDog_timer ENDP.....</b>	<b>76</b>
<b>B</b>	<b>Installing PC/104 Modules .....</b>	<b>79</b>
	<b>Installing PC/104 modules.....</b>	<b>80</b>





## **General Information**

This chapter provides background information for the PCM-4335.

Sections include:

- Card specifications
- Board layout

# Introduction

---

The PCM-4335 comes equipped with an embedded microcontroller which is STPC 486 DX-66. In addition, it comes with one RS-232 and one RS-232/422/485 serial port. One bi-directional printer port supporting SPP, ECP and EPP modes, an IDE HDD interface and a floppy disk controller. With its industrial grade reliability, the PCM-4335 can operate continuously at temperatures up to 140° F (60° C).

The PCM-4335 is specially designed as a compact all-in-one CPU card which incorporates a PC/104 connector into its design, making without backplane SBC applications possible. The numerous features provide an ideal price/performance solution for high-end commercial and industrial applications where stability and reliability are essential.

The PCM-4335 features an SVGA interface which supports CRT and Flat Panel (TFT, STN, Mono and EL displays) both , with 2MB SDRAM (built in chip) display memory.

# Specifications

---

## **Standard SBC functions**

**CPU:** STPC Client

**BIOS:** AMI 128KB FLASH BIOS

**Chipset:** STPC Client

**Super I/O Chipset:** Winbond W83977F

**RAM memory:** 4MB to 64MB. One 144-pin SODIMM socket on board.

**Enhanced IDE hard disk drive interface:** Support up to two hard disk drives. BIOS auto-detect. Supports PIO mode 4 and Bus Master. 22 x 2 header, pitch 2.00mm.

**Floppy disk drive interface:** Supports up to two floppy disk drives, 5.25" (360KB and 1.2MB) and /or 3.5" (720KB, 1.44MB and 2.88MB). 17 x 2 header, pitch 2.54mm.

**Multi-mode parallel port:** Configured to LPT1, LPT2, LPT3 or disabled. Supports SPP, ECP and EPP. 13 x 2 header, pitch 2.54mm.

**Serial ports:** One RS-232 serial port, one RS-232/422/485 serial ports. Ports can be configured as COM1, COM2, COM3, COM4 or disabled individually. Two 16C550 serial UARTs. 5 x 2 header, pitch 2.54mm for RS-232 x 2

**Keyboard/mouse connector:** 6 pin mini DIN connector supports standard PC/AT keyboard and PS/2 mouse.

**Battery:** Lithium battery for up to 10 years data retention.

**Watchdog Timer:** Can generate a system reset, or IRQ15. Support Windows 3.1, Windows 95. Software selectable timeout interval. (1 min. ~ 255 min., 1 min./step)

**DMA channels:** 7

**Interrupt levels:** 15

**Power connector:** 4 pin 3 1/2" FDD power connector.

**Power management:** I/O peripheral devices support power saving and doze/standby/suspend modes. APM 1.2 compliant.

## **Flat panel VGA interface**

**Chipset:** C&T 69000

**Display memory:** 2MB SDRAM built in chip.

**Display type:** Supports CRT and flat panel (TFT, DSTN, and mono) displays. Can display both CRT and flat panel simultaneously.

**Resolution:** Up to 1024x768@64K colors.

## **SSD interface**

One 32-pin DIP socket supports M-systems DiskOnChip 2000 series, memory capacity from 2MB to 144MB.

## **Mechanical and environmental**

**Power supply voltage:** +5V (4.75V to 5.25V)

**Max. power requirements:** +5V @ 2A

**Operating temperature:** 32 to 140°F (0 to 60°C)

**Board Size:** 96mm x 90mm

**Weight:** 0.2 Kg

## **Installation**

This chapter explains set up procedures for the PCM-4335 hardware, including instructions on setting jumpers and connecting peripherals, switches and indicators. Be sure to read all safety precautions before you begin the installation procedure.

## **AMIBIOS Setup**

This chapter describes how to set the BIOS configuration data.

# General information

---

AMIBIOS Setup configures system information that is stored in CMOS RAM.

## Starting AMIBIOS setup

As POST executes, the following appears;

Hit <DEL> if you want to run SETUP

Press <DEL> to run AMIBIOS setup.

## AMIBIOS main menu

The AMIBIOS setup screen appears as follows:

AMIBIOS SETUP — BIOS SETUP UTILITIES (C) 1995 American Megatrends, Inc. All Rights Reserved
Standard CMOS Setup Advanced CMOS Setup Advanced Chipset Setup Power Management Setup PCI/Plug and Play Setup Peripheral Setup Change Supervisor Password Auto Configuration with Optimal Settings Auto Configuration with Fail Safe Settings Save Settings and Exit Exit Without Saving
Standard CMOS setup for changing time, date, hard disk type, etc. ESC: Exit    -. :Sel    F2/F3: Color    F10: Save & Exit

## Using a mouse with AMIBIOS setup

AMIBIOS Setup can be accessed via keyboard, mouse. The mouse click functions are:

- single click to change or select both global and current fields
- double click to perform an operation in the selected field

## Using the keyboard with AMIBIOS setup

AMIBIOS Setup has a built-in keyboard driver that uses simple keystroke combinations:

<b>Keystroke</b>	<b>Function</b>
<tab>	Move to the next window or field.
→, ←, ↑, ↓	Move to the next field to the right, left, above, or below.
<ENTER>	Select the current field.
+	Increments a value.
-	Decrements a value.
<ESC>	Close the current operation and return to the previous level.
<PgUp>	Return to the previous page.
<PgDn>	Advance to the next page.
<Home>	Return to the beginning of the text.
<End>	Advance to the end of the text.
<ALT>+H	Access a help window.
<ALT>+<Spacebar>	Exit AMIBIOS Setup.
Alphabetic keys	A to Z are used in the Virtual keyboard, and are not case sensitive.
Numeric keys	0 to 9 are in the Virtual keyboard and Numeric keypad.



# Standard CMOS setup

The AMIBIOS Setup options described in this section are selected by choosing the Standard CMOS Setup from the AMI-BIOS Setup main menu selection screen, as shown below.

```

AMIBIOS SETUP — BIOS SETUP UTILITIES
(C) 1995 American Megatrends, Inc. All Rights Reserved

Standard CMOS Setup
Advanced CMOS Setup
Advanced Chipset Setup
Power Management Setup
PCI/Plug and Play Setup
Peripheral Setup
Change Supervisor Password
Auto Configuration with Optimal Settings
Auto Configuration with Fail Safe Settings
Save Settings and Exit
Exit Without Saving

Standard CMOS setup for changing time, date, hard disk type, etc.
ESC: Exit  --:Sel  F2/F3: Color  F10: Save & Exit
    
```

Press enter, the Standard CMOS Setup screen appears:

```

AMIBIOS SETUP — STANDARD CMOS SETUP
(C) 1995 American Megatrends, Inc. All Rights Reserved

Date (mm/dd/yyyy): Wed Sep 10, 1998
Time (hh/mm/ss): 12: 19: 46

Floppy Drive A: 1.44 MB 3½
Floppy Drive B: Not Installed

          Type Size Cyln Head WPcom  Sec  LBA  Blk  PIO  32Bit
Pri Master : AUTO                On  On  AUTO  Off
Pri Slave  : AUTO                On  On  AUTO  Off

Boot Sector Virus Protection      Disabled

Month:  Jan - Dec
Day:    01-31
Year:   1901 -2099

Esc: Exit  --:Sel
PgUp/PgDn: Modify
F2/F3: Color
    
```

### **Date and Time Configuration**

Select the Date and Time icon in the Standard CMOS setup. The current values for each category are displayed. Enter new values through the keyboard or hit the "+" or "-" key to change values.

### **Floppy A, Floppy B**

Select the appropriate specifications to configure the type of floppy drive that is attached to the system: 360 KB 5¼", 1.2 MB 5¼", 720 KB 3½", and/or 1.44 MB 3½". The settings have not been pre-installed.

### **Master Disk, Slave Disk**

Select the appropriate values to configure the hard disk type you are using for the master and the slave. Available types are *1-46*, *USER*, *AUTO*, *Not Installed*, and *CDROM*. The settings have not been preinstalled.

### **Boot Sector Virus Protection**

Enabling this option allows the system to issue a warning when any program (or virus) issues a disk format command or attempts to write to the boot sector of the hard disk drive. Further confirmation is required before accessing this particular section of the hard disk drive.

## Advanced CMOS setup

---

Select the Advanced CMOS Setup icon from the AMIBIOS Setup main menu to enter Advanced CMOS setup.

The "Advanced CMOS Setup" options described in this section are the standard options as shown on the following screen.

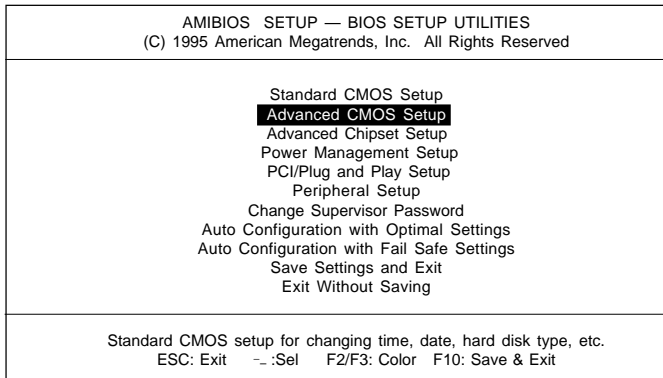

Press enter, the Advanced CMOS Setup screen appears:

AMIBIOS SETUP — ADVANCED CMOS SETUP (C) 1995 American Megatrends, Inc. All Rights Reserved		
Quick Boot	: Enabled	Available Options: Disabled Enabled
1st Boot Device	: IDE-0	
2nd Boot Device	: Floppy	
3rd Boot Device	: Reserved	
Try Other Boot Devices	: Yes	
Initial Display Mode	: BIOS	
Display Mode at Add-On ROM Init	: Force BIOS	
Floppy Access Control	: Read-Write	
Hard Disk Access Control	: Read-Write	
S.M.A.R.T. For Hard Disks	: Disabled	
BootUp Num-Lock	: On	
Floppy Drive Swap	: Disabled	
Floppy Drive Seek	: Disabled	
Primary Display	: VGA/EGA	
Display Device	: Both	
LCD Type	: 640 18B-TFT	
PS/2 Mouse Support	: Enabled	
System Keyboard	: Present	
Password Check	: Setup	
Boot To OS/2	: NO	
Internal Cache	: Write Back	
System BIOS Cacheable	: Enabled	
C000, 16K Shadow	: Cached	
C400, 16K Shadow	: Cached	
C800, 16K Shadow	: Disabled	
CC00, 16K Shadow	: Disabled	
D000, 16K Shadow	: Disabled	
D400, 16K Shadow	: Disabled	
D800, 16K Shadow	: Disabled	
DC00, 16K Shadow	: Disabled	ESC: Exit -_:Sel PgUp/PgDn: Modify F2/F3: Color

### Quick Boot

Set this option to *Enabled* to instruct AMIBIOS to boot quickly when the computer is powered on. This option replaces the old "Above 1 MB Memory Test" Advanced Setup option.

Setting	Description
<i>Disabled</i>	AMIBIOS tests all system memory. AMIBIOS waits up to 40 seconds for a READY signal from the IDE hard disk drive. AMIBIOS waits for .5 seconds after sending a RESET signal to the IDE drive to allow the IDE drive time to get ready again. AMIBIOS checks for a <Del> key press and runs AMIBIOS Setup if the key has been pressed.
<i>Enabled</i>	AMIBIOS does not test system memory above 1 MB. AMIBIOS does not wait up to 40 seconds for a READY signal from the IDE hard disk drive. If a READY signal is not received immediately from the IDE drive, AMIBIOS does not configure that drive. AMIBIOS does not wait for .5 seconds after sending a RESET signal to the IDE drive to allow the IDE drive time to get ready again. You cannot run AMIBIOS Setup at system boot, because there is no delay for the <i>Hit &lt;Del&gt; to run Setup</i> message.

### Boot Up Num Lock

Set this option to *Off* to turn the Num Lock key off when the computer is booted so you can use the arrow keys on both the numeric keypad and the keyboard. The settings are *On* or *Off*. The default setting is *On*.

### Floppy Drive Swap

Set this option to *Enabled* to permit drives A: or B: to be swapped. The settings are *Enabled* or *Disabled*. The default setting is *Disabled*.

### PS/2 Mouse Support

When this option is set to *Enabled*, AMIBIOS supports a PS/2-type mouse. The settings are *Enabled* or *Disabled*. The default setting is *Enabled*.

### **System Keyboard**

This option specifies that a keyboard is attached to the computer. The settings are *Present* or *Absent*. The default setting is *Present*.

### **Primary Display**

This option specifies the type of display monitor and adapter in the computer. The settings are *Mono*, *CGA40x25*, *CGA80x25*, *VGA/EGA*, or *Absent*. The default setting is *EGA/VGA*.

### **Display Device**

This option allows user to select the display device. The settings are *CRT*, *LCD*, and *Both*. The default setting is *Both*.

### **LCD type**

This option allows the user to select the LCD type.

#### **The PCM-4335 supports the following LCD types:**

Brand name	Model name	Format	PCM-4335
NEC	NL 6448AC33-10	640 x 480 TFT (12 bits)	Yes
Toshiba	LTM 10C209A	640 x 480 (18 bits)TFT	Yes
NEC	NL 8060AC26-04	800 x 600 TFT	Yes
Sharp	14 x 03	1024 x 768 TFT (36 bits)	Yes

### **Password Check**

This option enables password checking every time the computer is powered on or every time AMIBIOS Setup is executed. If *Always* is chosen, a user password prompt appears every time the computer is turned on. If *Setup* is chosen, the password prompt appears as AMIBIOS is executed. The default is *Setup*.

### **OS/2 Compatible Mode**

Set this option to *Enabled* to permit AMIBIOS to run with IBM OS/2. The settings are *Enabled* or *Disabled*. The default setting is *Disabled*.

### **System BIOS cacheable**

When this option is set to *Enabled*, the contents of the F0000h system memory segment can be read from or written to L2 cache memory. The contents of the F0000h memory segment are always copied from the BIOS ROM to system RAM for faster execution.

The settings are *Enabled* or *Disabled*. The default setting is *Disabled*.

## ROM Location Setting

C000, 16K Shadow	C400, 16K Shadow
C800, 16K Shadow	CC00, 16K Shadow
D000, 16K Shadow	D400, 16K Shadow
D800, 16K Shadow	DC00, 16K Shadow

These options control the location of the contents of the 16KB of ROM beginning at the specified memory location. If no adapter ROM is using the named ROM area, this area is made available to the local bus. The settings are:

Setting	Description
<i>Shadow</i>	The contents of C0000h - C3FFFh are written to the same address in system memory (RAM) for faster execution.
<i>Enabled</i>	If an adapter ROM will be using the named ROM area, ROM area are written to the same address in system memory (RAM) for faster execution. Also, the contents of the RAM area can be read from and written to cache memory.
<i>Disabled</i>	The video ROM is not copied to RAM. The contents of the video ROM cannot be read from or written to cache memory.



# Advanced chipset setup

Select the Advanced Chipset Setup from the AMIBIOS Setup main menu to enter the Chipset Setup. The following configurations are based on the manufacturer's default settings.

This section allows you to configure the system based on the specific features of the installed chipset. This chipset manages bus speeds and access to system memory resources, such as DRAM and the external cache. It also coordinates communications between the conventional ISA bus and the PCI bus. It must be stated that these items should never need to be altered. The default settings have been chosen, because they provide the best operating conditions for your system.

AMIBIOS SETUP — BIOS SETUP UTILITIES (C) 1995 American Megatrends, Inc. All Rights Reserved	
Standard CMOS Setup Advanced CMOS Setup <b>Advanced Chipset Setup</b> Power Management Setup PCI/Plug and Play Setup Peripheral Setup Change Supervisor Password Auto Configuration with Optimal Settings Auto Configuration with Fail Safe Settings Save Settings and Exit Exit Without Saving	
Standard CMOS setup for changing time, date, hard disk type, etc. ESC: Exit --:Sel F2/F3: Color F10: Save & Exit	

AMIBIOS SETUP — ADVANCED CHIPSET SETUP (C) 1995 American Megatrends, Inc. All Rights Reserved																		
<table border="1"> <tr> <td style="background-color: black; color: white;"><b>ISA CLK</b></td> <td style="background-color: black; color: white;"><b>:14MHz/2</b></td> </tr> <tr> <td>DRAM Type/Timing</td> <td>:User Setup</td> </tr> <tr> <td>DRAM Bank 0</td> <td>:EDO 60us</td> </tr> <tr> <td>DRAM Bank 1</td> <td>:EDO 60us</td> </tr> <tr> <td>Memory Hole</td> <td>:Disabled</td> </tr> <tr> <td>PCI to Host Read Prefetch</td> <td>:Disabled</td> </tr> <tr> <td>PCI to Host write posting</td> <td>:Disabled</td> </tr> <tr> <td>Watchdog Timer Support</td> <td>:Enabled</td> </tr> </table>	<b>ISA CLK</b>	<b>:14MHz/2</b>	DRAM Type/Timing	:User Setup	DRAM Bank 0	:EDO 60us	DRAM Bank 1	:EDO 60us	Memory Hole	:Disabled	PCI to Host Read Prefetch	:Disabled	PCI to Host write posting	:Disabled	Watchdog Timer Support	:Enabled	Available Options: 14MHz/2 PCICLK/4	ESC: Exit --:Sel PgUp/PgDn: Modify F2/F3: Color
<b>ISA CLK</b>	<b>:14MHz/2</b>																	
DRAM Type/Timing	:User Setup																	
DRAM Bank 0	:EDO 60us																	
DRAM Bank 1	:EDO 60us																	
Memory Hole	:Disabled																	
PCI to Host Read Prefetch	:Disabled																	
PCI to Host write posting	:Disabled																	
Watchdog Timer Support	:Enabled																	

# Power management setup

The Power management setup offers options to help reduce power consumption. To see the options in this group, choose the Power management setup icon from the AMIBIOS setup main menu.

AMIBIOS SETUP — BIOS SETUP UTILITIES (C) 1995 American Megatrends, Inc. All Rights Reserved	
Standard CMOS Setup Advanced CMOS Setup Advanced Chipset Setup <b>Power Management Setup</b> PCI/Plug and Play Setup Peripheral Setup Change Supervisor Password Auto Configuration with Optimal Settings Auto Configuration with Fail Safe Settings Save Settings and Exit Exit Without Saving	
Standard CMOS setup for changing time, date, hard disk type, etc. ESC: Exit --:Sel F2/F3: Color F10: Save & Exit	

AMIBIOS SETUP — ADVANCED CHIPSET SETUP (C) 1995 American Megatrends, Inc. All Rights Reserved		
<b>Power Management/APM</b>	<b>:Disabled</b>	Available Options:
Hardware Auto Power Saving	:Disabled	Disabled
Green PC Monitor Power State	:Stand By	Enabled
Video Power Down Mode	:Disabled	
Hard Disk Power Down Mode	:Dsiabled	
Hard Disk Time Out (Minute)	:Disabled	
Doze Time Out (Miunte)	:Disabled	
Standby Time Out (Miunte)	:Disabled	
Suspend Time Out (Miunte)	:Disabled	
Full-On Clock Throttle Ratio	:Normal Clock	
Power-Down Clock Throttle Ratio	:Normal Clock	
STPCLK# Modulation Period	:64 us	
Display Activity	:Ignore	
DMA Activity	:Ignore	
PCI Master Activity	:Ignore	
Parallel IO Activity	:Ignore	
Serial IO Activity	:Ignore	
Keyboard Activity	:Monitor	
Floppy disk Activity	:Ignore	
Hard Disk Activity	:Ignore	
IRQ 1-15 Interrupt	:Ignore	ESC: Exit --:Sel
System Timer Interrupt	:Ignore	PgUp/PgDn: Modify
NMI Interrupt	:Ignore	F2/F3: Color

## **Power management/APM**

Power management lets you set up your computer to save electricity when it is not actively in use by putting the system into progressively greater power saving modes. In the power management scheme there are four system states which proceed in the following sequence:

*Disabled* → *SMI*

There are two selections for Power Management (Mode):

<i>Disabled</i>	Turns off PM
<i>SMI</i>	Maximized power saving by activating maximum power saving settings after one minute of system inactivity.

With the exception of *Disabled*, SMI selections have "fixed-mode" settings. Therefore, when PM is set to *Disabled*, some items which are predefined will become unmodifiable.

## **Power down HDD mode**

When enabled and after the selected time of system inactivity, the hard disk drive will be powered down while all other devices will remain active.

## **Doze mode timeout**

This sets the period of system inactivity after which the system goes into *Doze* mode, the most limited power saving state. The settings range from 10 seconds to 2 hours and can be set manually when power management is in *SMI*. The default setting is *Disabled*. When the system goes into power saving mode, power management will skip to the next mode in the sequence if this is disabled.

**Standby mode timeout**

This sets the period of system inactivity after which the system goes into *Standby* mode, the intermediate power saving state. The settings range from 10 seconds to 2 hours and can be set manually when power management is in *SMI*. The default setting is *Disabled*. When the system goes into power saving mode, power management will skip to the next mode in the sequence if this is disabled.

**Suspend mode timeout**

This sets the period of system inactivity after which the system goes into *Suspend* mode, the maximum power saving state. The settings range from 10 seconds to 2 hours and can be set manually when power management is in *SMI*. The default setting is *Disabled*. When the system goes into power saving mode, power management will skip to the next mode in the sequence if this is disabled.

## PCI/PLUG and play setup

PCI/PnP setup options are displayed by choosing the PCI/PnP setup icon from the AMIBIOS setup main. All PCI/PnP setup options are described in this section.

AMIBIOS SETUP — BIOS SETUP UTILITIES (C) 1995 American Megatrends, Inc. All Rights Reserved
Standard CMOS Setup Advanced CMOS Setup Advanced Chipset Setup Power Management Setup <b>PCI/Plug and Play Setup</b> Peripheral Setup Change Supervisor Password Auto Configuration with Optimal Settings Auto Configuration with Fail Safe Settings Save Settings and Exit Exit Without Saving
Standard CMOS setup for changing time, date, hard disk type, etc. ESC: Exit    -:Sel    F2/F3: Color    F10: Save & Exit

### Plug and Play Aware OS

Set this option to *Yes* if the operating system installed in the computer is Plug and Play aware. AMIBIOS only detects and enables PnP ISA adapter cards that are required for system boot. The Windows 95 operating system detects and enables all other PnP-aware adapter cards. Set this option to *No* if the operating system (such as DOS, OS/2, Windows 3.x) does not use PnP.

*You must set this option correctly or PnP-aware adapter cards installed in your computer will not be configured properly.*

The settings are Yes or No default settings is no.

AMIBIOS SETUP — ADVANCED CHIPSET SETUP		
(C) 1995 American Megatrends, Inc. All Rights Reserved		
<b>Plug and Play Aware O/S</b>	: No	Available Options:
PCI Latency Timer (PCI Clocks)	: 64	No
PCI VGA Palette Snoop	: Display	Yes
PCI IDE Bus Master	: Display	
Off Board PCI IDE Card	: Auto	
Off Board PCI IDE Primary IRQ	: Disabled	
Off Board PCI IDE Secondary IRQ	: Disabled	
DMA Channel 0	: PnP	
DMA Channel 1	: PnP	
DMA Channel 3	: PnP	
DMA Channel 5	: PnP	
DMA Channel 7	: PnP	
IRQ3	: PCI/PnP	
IRQ4	: PCI/PnP	
IRQ5	: PCI/PnP	
IRQ7	: PCI/PnP	
IRQ9	: PCI/PnP	ESC: Exit    -:Sel
IRQ10	: PCI/PnP	PgUp/PgDn: Modify
IRQ11	: PCI/PnP	F2/F3: Color

### PCI latency Timer (in PCI Clocks)

This option sets the latency of all PCI devices on the PCI bus. The settings are in units equal to PCI clocks. The settings are 32, 64, 96, 128, 160, 192, 224, or 248.

### PCI IDE BusMaster

Set this option to Enabled to specify that the IDE controller on the PCI local bus has bus mastering capability. The settings are *Disabled* or *Enabled*. The default setting is *Disabled*.

### Offboard PCI IDE Card

This option specifies if an offboard PCI IDE controller adapter card is used in the computer. You must also specify the PCI expansion slot on the motherboard where the offboard PCI IDE controller card is installed. If an offboard PCI IDE controller is used, the onboard IDE controller on the motherboard is automatically disabled.

If *Auto* is selected, AMIBIOS automatically determines the correct setting for this option.

**IRQ3**  
**IRQ4**  
**IRQ5**  
**IRQ7**  
**IRQ9**  
**IRQ10**  
**IRQ11**

These options specify bus that the named interrupt request lines (IRQs) are used on. These options allow you to specify IRQs for use by legacy ISA adapter cards.

These options determine if AMIBIOS should remove an IRQ from the pool of available IRQs passed to BIOS configurable devices. The available IRQ pool is determined by reading the ESCD NVRAM. If more IRQs must be removed from the pool, the end user can use these PCI/PnP Setup options to remove the IRQ by assigning the option to the *ISA/EISA* setting. Onboard I/O is configurable by AMIBIOS. The IRQs used by onboard I/O are configurable by AMIBIOS. The IRQs used by onboard I/O are configured as *PCI/PnP*.

The settings are *PCI/PnP* or *ISA/EISA*. The default settings are *PCI/PnP*.

# Peripheral setup

Peripheral Setup options are displayed by choosing the Peripheral Setup icon from the AMIBIOS Setup main menu. All Peripheral Setup options are described in this section:

AMIBIOS SETUP — BIOS SETUP UTILITIES (C) 1995 American Megatrends, Inc. All Rights Reserved	
Standard CMOS Setup Advanced CMOS Setup Advanced Chipset Setup Power Management Setup PCI/Plug and Play Setup <b>Peripheral Setup</b> Change Supervisor Password Auto Configuration with Optimal Settings Auto Configuration with Fail Safe Settings Save Settings and Exit Exit Without Saving	
Standard CMOS setup for changing time, date, hard disk type, etc. ESC: Exit    --:Sel    F2/F3: Color    F10: Save & Exit	

AMIBIOS SETUP — PERIPHERAL SETUP (C) 1995 American Megatrends, Inc. All Rights Reserved		
<b>Onboard FDC</b>	:Auto	Available Options:
Onboard Serial PortA	:Auto	Disabled
Onboard Serial PortB	:Auto	Enabled
Onboard Parallel Port	:Auto	Auto
Parallel Port Mode	:ECP	
EPP Version	:N/A	
Parallel Port IRQ	:Auto	ESC: Exit    --:Sel
Parallel Port DMA Channel	:Auto	PgUp/PgDn: Modify
Onboard SID1 PCI IDE	:Enabled	F2/F3: Color

## Onboard FDC

This option enables the floppy drive controller on the motherboard. The settings are *Enabled*, or *Disabled*.

## Onboard Parallel Port

This option enables the parallel port on the motherboard and specifies the parallel port base I/O port address. The settings are *Disabled*, *278*, *378*, and *3BC*. The default setting is *Enabled*.



### **Parallel Port Mode**

This option specifies the parallel port mode. ECP and EPP are both bidirectional data transfer schemes that adhere to the IEEE P1284 specification. The settings are:

Setting	Description
<i>Normal</i>	The normal parallel port mode is used. This is the default setting.
<i>EPP</i>	The parallel port can be used with devices that adhere to the Enhanced Parallel Port (EPP) specification. EPP uses the existing parallel port signals to provide asymmetric bidirectional data transfer driven by the host device.
<i>ECP</i>	The parallel port can be used with devices that adhere to the Extended Capabilities Port (ECP) specification. ECP uses the DMA protocol to achieve transfer rates of approximately 2.5 Mbs. ECP provides symmetric bidirectional communications.

### **ECP DMA**

This option is setting for the **Parallel Port Mode**.

The settings are *DMA, CH (channel) 0, DMA CH 1, DMA CH2, or DMA CH3.*

### **Parallel Port IRQ**

IRQ7 is used for the Parallel Port (LPT 1). The IRQ can be changed to IRQ5.

### **Onboard Serial Port 1/2/3/4**

This option enables serial port 1 on the motherboard and specifies the base I/O port address for serial port 1~4.

The settings are *Disabled, 3F8h, 3E8h, 2E8h, and 2F8h.*

# Change supervisor password

---

- 1) Select this option from the main menu
- 2) Enter the Password and Press <Enter>
- 3) Retype the Password and Press <Enter>

If you forget the password, please contact your distributor for another password which you can use to enter the AMIBIOS setup and change your own password.

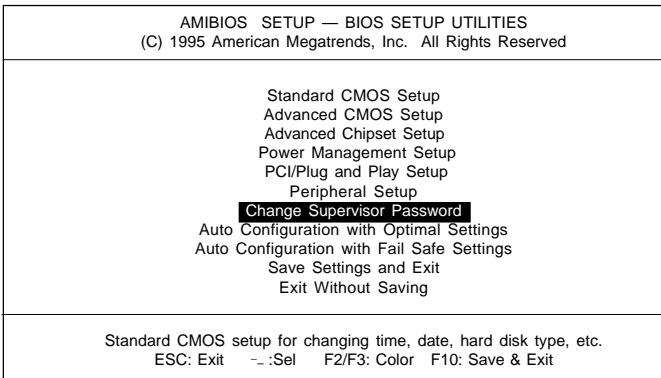

# Auto configuration with optimal settings

---

You can load the optimal default settings for the AMIBOIS setup options by selecting it from the main menu. The optimal default settings are best case values that should optimize system performance. If CMOS RAM is corrupted, the optimal settings are loaded automatically.

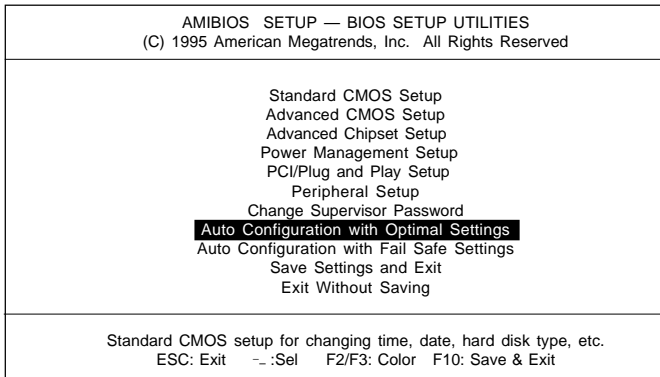

# Auto configuration with fail safe settings

---

You can load the Fail Safe settings for the AMIBIOS setup options by selecting it from the main menu. The Fail Safe settings provide the most stable settings, though they may not provide optimal performance. Use this option as a diagnostic aid if the system is behaving erratically.

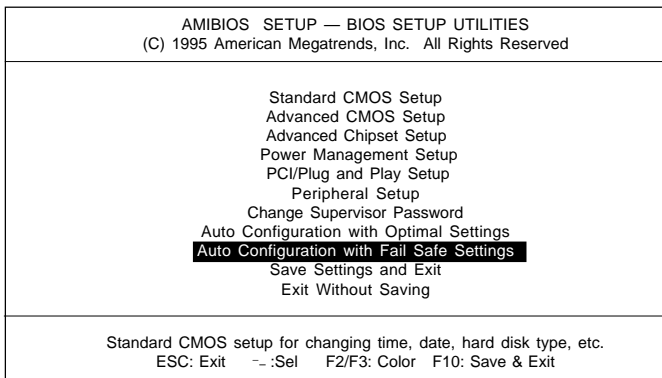

## Save settings and exit

---

If you select this option and press <Enter>, the values entered in the setup utilities will be recorded in the chipset's CMOS memory. The microprocessor will check this every time you turn your system on and compare this to what it finds as it checks the system. This record is required for the system to operate.

AMIBIOS SETUP — BIOS SETUP UTILITIES (C) 1995 American Megatrends, Inc. All Rights Reserved
Standard CMOS Setup Advanced CMOS Setup Advanced Chipset Setup Power Management Setup PCI/Plug and Play Setup Peripheral Setup Change Supervisor Password Auto Configuration with Optimal Settings Auto Configuration with Fail Safe Settings <b>Save Settings and Exit</b> Exit Without Saving
Standard CMOS setup for changing time, date, hard disk type, etc. ESC: Exit    --:Sel    F2/F3: Color    F10: Save & Exit

## Exit without saving

---

Selecting this option and pressing <Enter> lets you exit the Setup program, without recording any new values or changing old ones.

AMIBIOS SETUP — BIOS SETUP UTILITIES (C) 1995 American Megatrends, Inc. All Rights Reserved
Standard CMOS Setup Advanced CMOS Setup Advanced Chipset Setup Power Management Setup PCI/Plug and Play Setup Peripheral Setup Change Supervisor Password Auto Configuration with Optimal Settings Auto Configuration with Fail Safe Settings Save Settings and Exit <b>Exit Without Saving</b>
Standard CMOS setup for changing time, date, hard disk type, etc. ESC: Exit    --:Sel    F2/F3: Color    F10: Save & Exit



## Jumpers and connectors

---

Connectors on the board link it to external devices such as hard disk drives, a keyboard, or floppy drives. In addition, the board has a number of jumpers that allow you to configure your system to suit your application.

The table below lists the function of each of the board jumpers and connectors:

---

### Jumpers and connectors

---

<b>Number</b>	<b>Function</b>
CN1	Fan connector
CN2	FDD connector
CN3	COM1
CN4	HDD connector
CN5	Parallel port
CN6	VGA connector
CN7	LCD panel connector
CN8	COM2 (RS-232/422/485)
CN9	External KB/PS2 mouse connector
CN10	Power connector
J1	-5V/-12V Voltage input connector
JP1	DOC address select
JP2	RS-232/422/485 select (COM2)
JP3	Clear CMOS
JP4	Keyboard lock
JP5	LCD panel voltage select
JP6	Hardware reset
JP7	LCD SHF/ASHF clock select
SP1	External speaker connector

---



# Locating jumpers and connector

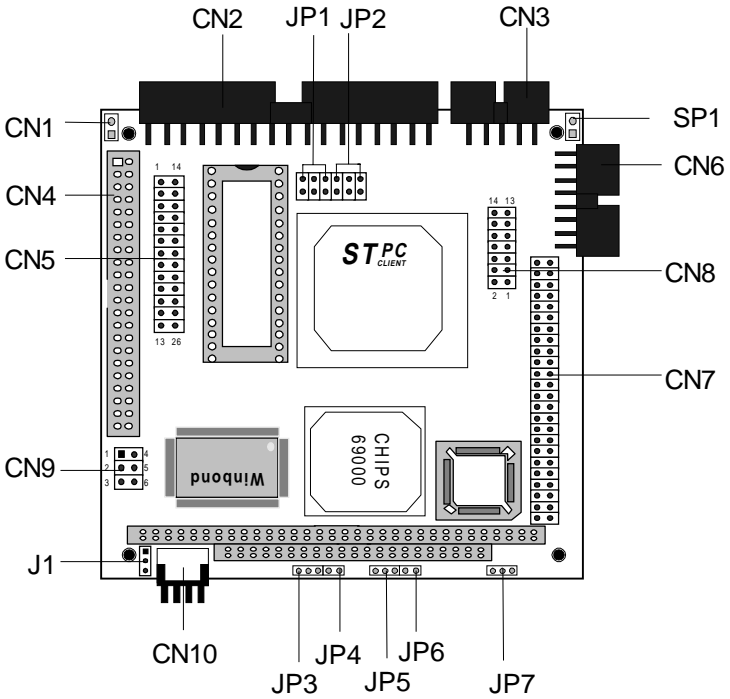

# Setting jumpers

---

You configure your card to match the needs of your application by setting jumpers. A jumper is the simplest kind of electric switch. It consists of two metal pins and a small metal clip (often protected by a plastic cover) that slides over the pins to connect them. To “close” a jumper you connect the pins with the clip. To “open” a jumper you remove the clip. Sometimes a jumper will have three pins, labeled 1, 2 and 3. In this case you would connect either pins 1 and 2 or 2 and 3.

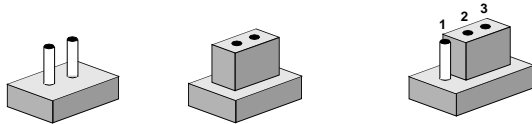

**Open**

**Closed**

**Closed 2-3**

The jumper settings are schematically depicted in this manual as follows:



**Open**

**Closed**

**Closed 2-3**

A pair of needle-nose pliers may be helpful when working with jumpers.

If you have any doubts about the best hardware configuration for your application, contact your local distributor or sales representative before you make any changes.

Generally, you simply need a standard cable to make most connections.

## Safety precautions

---

**Warning!**  Always completely disconnect the power cord from your chassis whenever you are working on it. Do not make connections while the power is on because sensitive electronic components can be damaged by the sudden rush of power. Only experienced electronics personnel should open the PC chassis.

**Caution!**  Always ground yourself to remove any static charge before touching the CPU card. Modern electronic devices are very sensitive to static electric charges. Use a grounding wrist strap at all times. Place all electronic components on a static-dissipative surface or in a static-shielded bag when they are not in the chassis.

# Fan power connector (CN1)

PCM-4335 offer +5V to drive a fan for CPU.

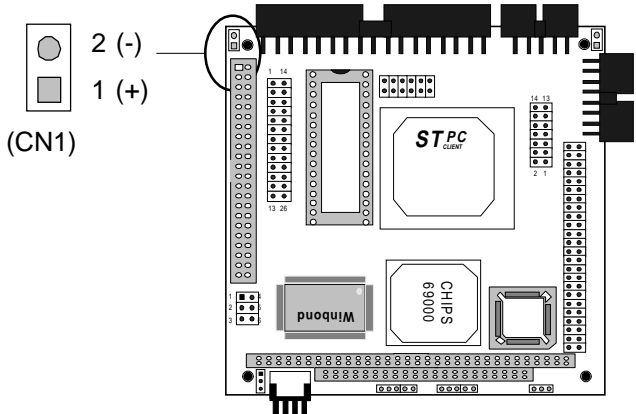

## Floppy drive connector (CN2)

---

You can attach up to two floppy disks to the PCM-4335's on-board controller. You can use any combination of 5¼" (360 KB and 1.2 MB) and/or 3½" (720 KB, 1.44 MB, and 2.88 MB) drives.

The PCM-4335 CPU card comes with a 34-pin daisy-chain drive connector cable. On one end of the cable is a 34-pin flat-cable connector. There are two sets of floppy disk drive connectors, one in the middle, and one on the other end. Each set consists of a 34-pin flat-cable connector (usually used for 3.5" drives) and a printed-circuit board connector (usually used for 5.25" drives).

### Connecting the floppy drive

1. Plug the 34-pin flat-cable connector into the floppy disk connector.
2. Attach the appropriate connector on the other end of the cable to the floppy drive(s). You can use only one connector in the set. The set on the end (after the twist in the cable) connects to the A: floppy. The set in the middle connects to the B: floppy.

### Pin assignments

The following table lists the pin assignments for the floppy disk connector:

Floppy drive connector (CN2)			
Pin	Signal	Pin	Signal
1~33 (odd)	GND	2	High density
4, 6	Unused	8	Index
10	Motor enable A	12	Driver select B
14	Driver select A	16	Motor enable B
18	Direction	20	Step pulse
22	Write data	24	Write enable
26	Track 0	28	Write protect
30	Read data	32	Select head
34	Disk Change		

# Serial port connectors (CN3/COM1, CN8/COM2)

The PCM-4335 offers two serial ports. One RS-232 and one RS-232/422/485. These ports allow you to connect them to serial devices (a mouse, printers, etc.), or a communication network. You also can select or disable the address for each port with the BIOS peripheral setup program.

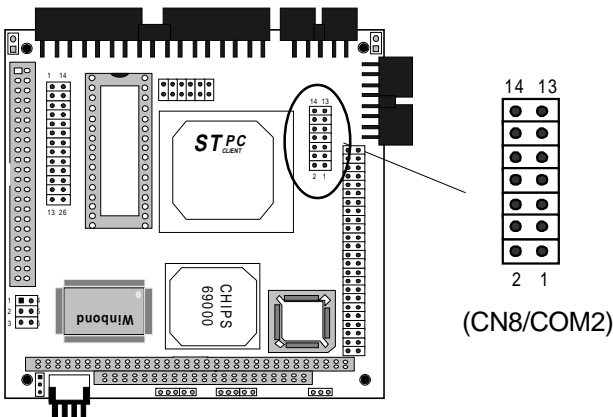
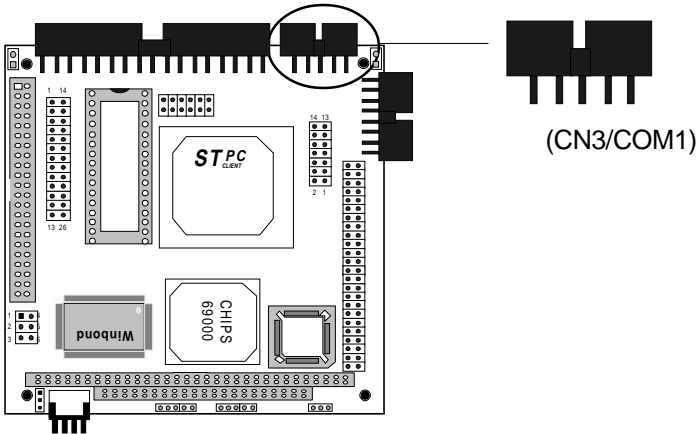

## **RS-232 connector (CN3/COM1)**

The following table shows the pin assignments for the card's RS-232 port:

RS-232 connector (CN3/COM1)	
<b>Pin</b>	<b>Signal</b>
1	DCD
2	RX
3	TX
4	DTR
5	GND
6	DSR
7	RTS
8	CTS
9	RI
10	NC

## **RS-232/422/485 connector (CN8/COM2)**

RS-232/422/485 connector (CN8/COM2)	
<b>Pin</b>	<b>Signal</b>
1	DCD
2	RX
3	TX
4	DTR
5	GND
6	DSR
7	RTS
8	CTS
9	RI
10	NC
11	B485TXD+
12	B485TXD-
13	B422RXD+
14	B422RXD-

## IDE hard drive connector (CN4)

---

You can attach one or two Enhanced Integrated Device Electronics hard disk drives to the mainboard's internal controller. The mainboard's IDE controller uses a PCI local-bus interface. This advanced interface supports faster data transfer and allows the IDE hard drive to exceed 528 MB.

### Connecting the hard drive

Connecting drives is done in a daisy-chain fashion and requires one of two cables, depending on the drive size. 1.8" and 2.5" drives need a 1 x 44-pin to 2 x 44-pin flat-cable connector. 3.5" drives use a 1 x 44-pin to 2 x 40-pin connect.

Wire number 1 on the cable is red or blue, and the other wires are gray.

1. Connect one end of the cable to CN4. Make sure that the red (or blue) wire corresponds to pin 1 on the connector, which is labeled on the board (on the right side).
2. Plug the other end of the cable to the Enhanced IDE hard drive, with pin 1 on the cable corresponding to pin 1 on the hard drives. (see your hard drive's documentation for the location of the connector).

Connect a second drive as described above.

Unlike floppy drives, IDE hard drives can connect to either end of the cable. If you install two drives, you will need to set one as the master and one as the slave by using jumpers on the drives. If you install just one drive, set it as the master.



## Pin assignments

The following table lists the pin numbers and their respective signals:

### IDE hard drive connector (CN4)

IDE hard drive connector (CN4)			
Pin	Signal	Pin	Signal
1	IDE RESET	2	GND
3	DATA 7	4	DATA 8
5	DATA 6	6	DATA 9
7	DATA 5	8	DATA 10
9	DATA 4	10	DATA 11
11	DATA 3	12	DATA 12
13	DATA 2	14	DATA 13
15	DATA 1	16	DATA 14
17	DATA 0	18	DATA 15
19	SIGNAL GND	20	N/C
21	N/C	22	GND
23	IO WRITE	24	GND
25	IO READ	26	GND
27	IO CHANNEL READY	28	ALE
29	N/C	30	GND
31	IRQ14	32	IOCS16
33	ADDR 1	34	N/C
35	ADDR 0	36	ADDR 2
37	HARD DISK SELECT 0	38	HARD DISK SELECT 1
39	IDE ACTIVE	40	MGND
41	VCC	42	MVCC
43	GND	44	N/C

# Parallel port connector (CN5)

Normally, the parallel port is used to connect the card to a printer. The PCM-4335 includes an onboard parallel port, accessed through CN5, a 26-pin flat-cable connector. You need an adapter cable if you use a traditional DB-25 connector. The cable has a 26-pin connector on one end and a DB-25 connector on the other.

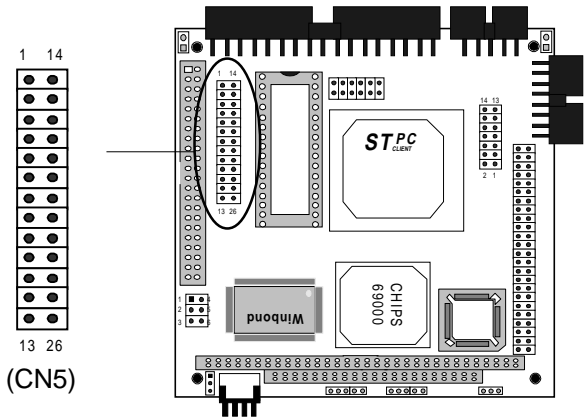

## Pin assignments

### Parallel port connector (CN5)

Pin	Signal	Pin	Signal
1	/STROBE	2	\AUTOFD
3	DO	4	ERR
5	D1	6	\INIT
7	D2	8	\SLCTINI
9	D3	10	GND
11	D4	12	GND
13	D5	14	GND
15	D6	16	GND
17	D7	18	GND
19	\ACK	20	GND
21	BUST	22	GND
23	PE	24	GND
25	SLCT	26	N/C

## Display connectors (CN6, CN7)

---

The PCM-4335 PCI SVGA interface can drive conventional CRT displays and is capable of driving a wide range of flat panel displays, including electroluminescent (EL), gas plasma, passive LCD, and active LCD displays. The card has two connectors to support these displays, one for standard CRT VGA monitors and one for flat panel displays.

### VGA display connector (CN6)

CN6 is a 16-pin, dual-in-line header used for conventional CRT displays. A simple one-to-one adapter can be used to match CN6 to a standard 15-pin D-SUB connector commonly used for VGA.

---

VGA display connector (CN6)

---

Pin	Signal	Pin	Signal
1	RED	9	SIGNAL GND
2	N/C	10	H-SYNC
3	GREEN	11	CHASSIS GND
4	SIGNAL GND	12	V-SYNC
5	BLUE	13	CHASSIS GND
6	N/C	14	N/C
7	N/C	15	CHASSIS GND
8	N/C	16	N/C

---

When the PCM-4335's power is applied, the control signal is low until just after the relevant flat panel signals are present.

Configuration of the VGA interface is done completely via the software utility. You don't have to set any jumpers.

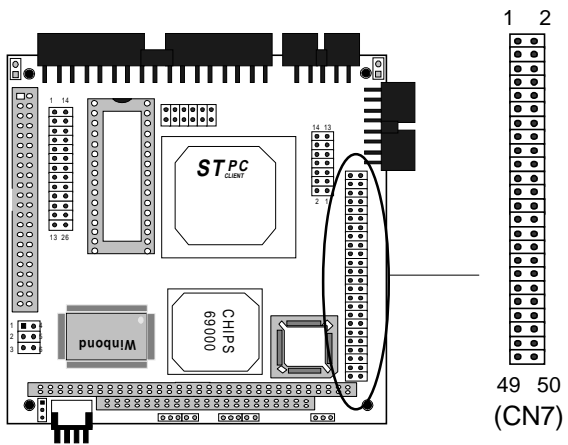

## LCD panel connector (CN7)

LCD panel connector (CN7)

Pin	Signal	Pin	Signal
1	+12 V <sub>DC</sub>	2	+12 V <sub>DC</sub>
3	GND	4	GND
5	+5 V <sub>DC</sub>	6	+5 V <sub>DC</sub>
7	ENAVEE	8	GND
9	P0	10	P1
11	P2	12	P3
13	P4	14	P5
15	P6	16	P7
17	P8	18	P9
19	P10	20	P11
21	P12	22	P13
23	P14	24	P15
25	P16	26	P17
27	P18	28	P19
29	P20	30	P21
31	P22	32	P23
33	P24	34	P25
35	SHF CLK	36	FLM (V SYS)
37	M	38	LP (H SYS)
39	GND	40	ENABKL
41	P26	42	P27
43	P28	44	P29
45	P30	46	P31
47	P32	48	P33
49	P34	50	P35

# Keyboard and PS/2 mouse connector (CN9)

The mainboard provides a keyboard connector which supports both a keyboard and a PS/2 style mouse. In most cases, especially in embedded applications, a keyboard is not used. The standard PC/AT BIOS will report an error or fail during power-on self-test (POST) after a reset if the keyboard is not present. The mainboard BIOS Advanced setup menu allows you to select "System Keyboard" under the "Present" or "Absent" selection. This allows no-keyboard operation in embedded system applications without the system halting under POST (power-on-self-test).

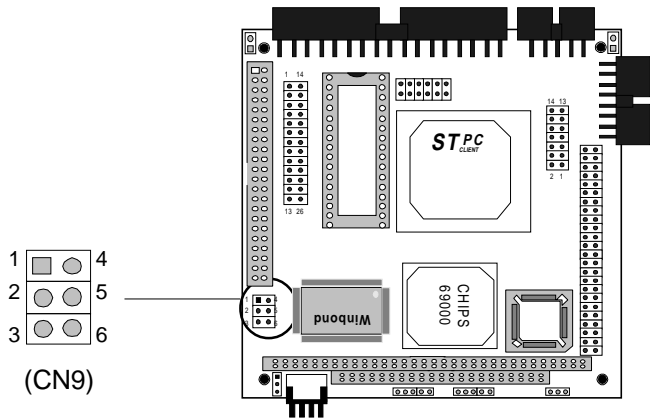

Keyboard and PS/2 mouse connector (CN9)

Pin	Signal
1	KB_Data
2	GND
3	MS_Data
4	KB_CLK
5	V <sub>CC</sub>
6	MS_CLK

# Power supply connector (CN10)

In single board computer without backplane applications, you will need to connect power directly to the PCM-4335 board using CN10. This connector is fully compatible with the standard PC power supply connectors(mini 4-pin). See the following table for its pin assignments:

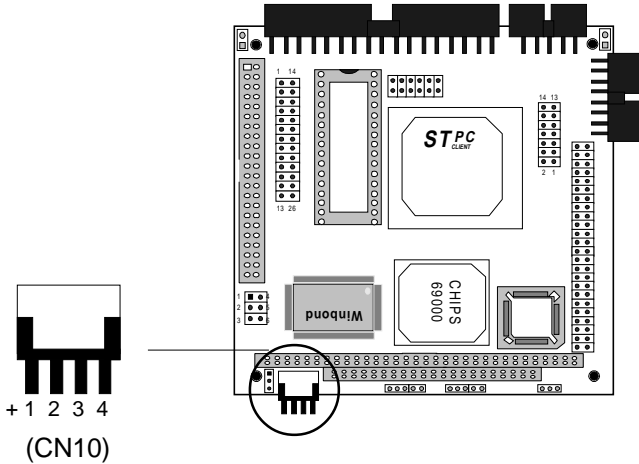

Power supply connector (CN10)

Pin	Function
1	+12 V
2	GND
3	GND
4	+5 V

## Exter power supply connector (J1)

The PCM-4335 can offer -5V & -12V voltages by input from the (J1) connector for expansion PC/104 application cards.

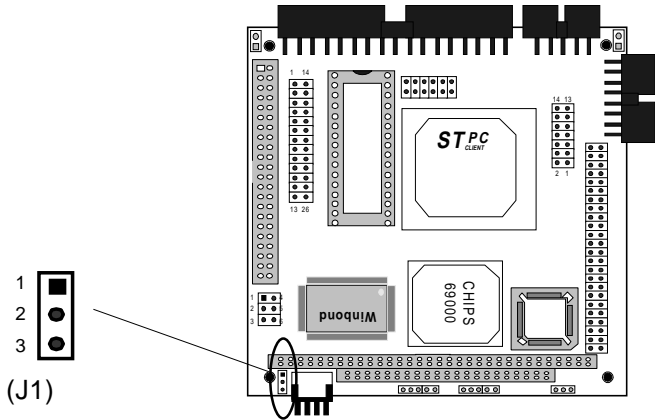

External power supply connector (J1)

Pin	Function
1	-5V
2	-12V
3	GND



# DOC address select (JP1)

The DiskOnChip 2000 occupies a 8 KB window in the upper memory address range of CC00 to DC00. You should ensure this does not conflict with any other device's memory address. JP1 controls the memory address of the Flash disk.

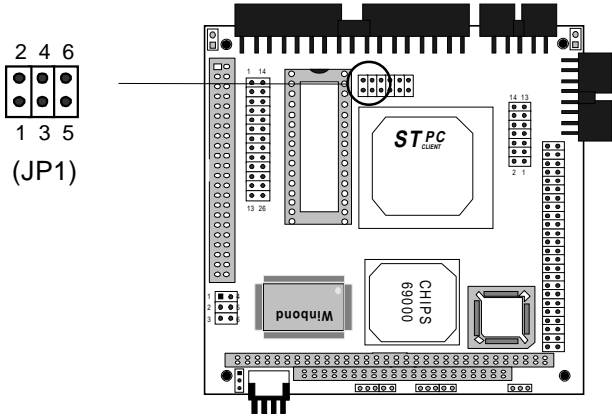

## DOC address setting (JP1)

Address	CC00	D000*	D400
	2 4 6 <input type="radio"/> <input type="radio"/> <input type="radio"/> <input type="checkbox"/> <input type="checkbox"/> <input type="checkbox"/> 1 3 5	2 4 6 <input checked="" type="radio"/> <input type="radio"/> <input type="radio"/> <input type="checkbox"/> <input type="checkbox"/> <input type="checkbox"/> 1 3 5	2 4 6 <input type="radio"/> <input checked="" type="radio"/> <input type="radio"/> <input type="checkbox"/> <input type="checkbox"/> <input type="checkbox"/> 1 3 5
	D800 <input checked="" type="radio"/> <input checked="" type="radio"/> <input type="radio"/> <input type="checkbox"/> <input type="checkbox"/> <input type="checkbox"/> 1 3 5	DC00 <input type="radio"/> <input type="radio"/> <input checked="" type="radio"/> <input type="checkbox"/> <input type="checkbox"/> <input type="checkbox"/> 1 3 5	Disable DOC <input type="radio"/> <input checked="" type="radio"/> <input checked="" type="radio"/> <input type="checkbox"/> <input type="checkbox"/> <input type="checkbox"/> 1 3 5

\*default

## RS-232/422/485 select (JP2)

The PCM-4335 offers two serial ports. One RS-232 and one RS-232/422/485.

The following charts show the available options:

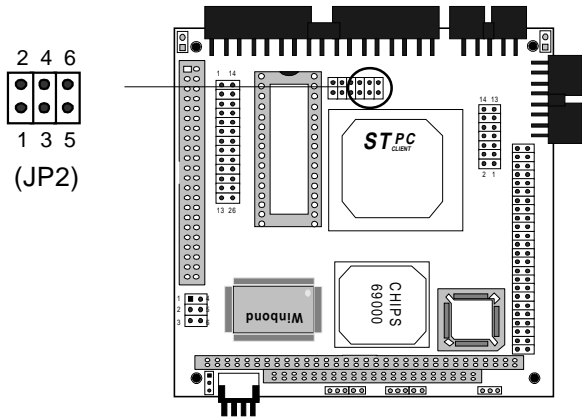

### RS-232/422/485 select (JP2)

*RS-232	RS-422	RS-485																																				
<table border="0"> <tr> <td>2</td><td>4</td><td>6</td> </tr> <tr> <td><input checked="" type="radio"/></td><td><input type="radio"/></td><td><input type="radio"/></td> </tr> <tr> <td>1</td><td>3</td><td>5</td> </tr> <tr> <td><input type="radio"/></td><td><input checked="" type="radio"/></td><td><input type="radio"/></td> </tr> </table>	2	4	6	<input checked="" type="radio"/>	<input type="radio"/>	<input type="radio"/>	1	3	5	<input type="radio"/>	<input checked="" type="radio"/>	<input type="radio"/>	<table border="0"> <tr> <td>2</td><td>4</td><td>6</td> </tr> <tr> <td><input type="radio"/></td><td><input checked="" type="radio"/></td><td><input type="radio"/></td> </tr> <tr> <td>1</td><td>3</td><td>5</td> </tr> <tr> <td><input type="radio"/></td><td><input checked="" type="radio"/></td><td><input type="radio"/></td> </tr> </table>	2	4	6	<input type="radio"/>	<input checked="" type="radio"/>	<input type="radio"/>	1	3	5	<input type="radio"/>	<input checked="" type="radio"/>	<input type="radio"/>	<table border="0"> <tr> <td>2</td><td>4</td><td>6</td> </tr> <tr> <td><input type="radio"/></td><td><input type="radio"/></td><td><input checked="" type="radio"/></td> </tr> <tr> <td>1</td><td>3</td><td>5</td> </tr> <tr> <td><input type="radio"/></td><td><input checked="" type="radio"/></td><td><input type="radio"/></td> </tr> </table>	2	4	6	<input type="radio"/>	<input type="radio"/>	<input checked="" type="radio"/>	1	3	5	<input type="radio"/>	<input checked="" type="radio"/>	<input type="radio"/>
2	4	6																																				
<input checked="" type="radio"/>	<input type="radio"/>	<input type="radio"/>																																				
1	3	5																																				
<input type="radio"/>	<input checked="" type="radio"/>	<input type="radio"/>																																				
2	4	6																																				
<input type="radio"/>	<input checked="" type="radio"/>	<input type="radio"/>																																				
1	3	5																																				
<input type="radio"/>	<input checked="" type="radio"/>	<input type="radio"/>																																				
2	4	6																																				
<input type="radio"/>	<input type="radio"/>	<input checked="" type="radio"/>																																				
1	3	5																																				
<input type="radio"/>	<input checked="" type="radio"/>	<input type="radio"/>																																				

\* default

# Clear CMOS (JP3)

You can connect an external switch to clear CMOS. This switch closes CLEAR CMOS and turns on the power, at which time the CMOS setup can be cleared.

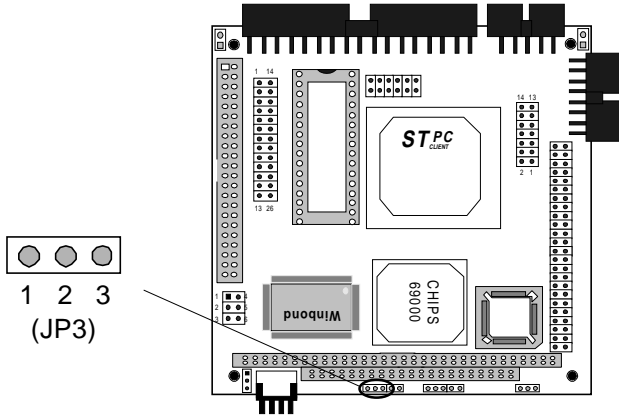

---

## Clear CMOS (JP3)

---

**Protect\***

**Clear CMOS**



---

\*default

## Keyboard lock function (JP4)

You can use a switch (or a lock) to disable the keyboard. In this state, the PC will not respond to any input. This is useful if you don't want anyone to change or stop a running program. Simply connect the switch between Pins 1 and 2. The pin assignments appear in the following table:

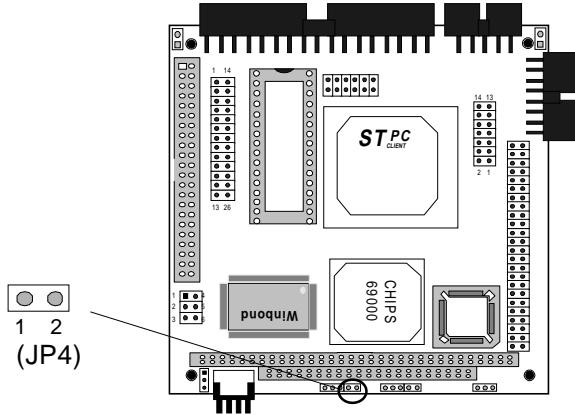

---

### Keyboard lock function (JP4)

---

Pin	Function
1	Keyboard lock
2	Ground

---

# LCD driving voltage select (JP5)

You can select the LCD connector (CN7) driving voltage by setting JP5. The configuration as follows

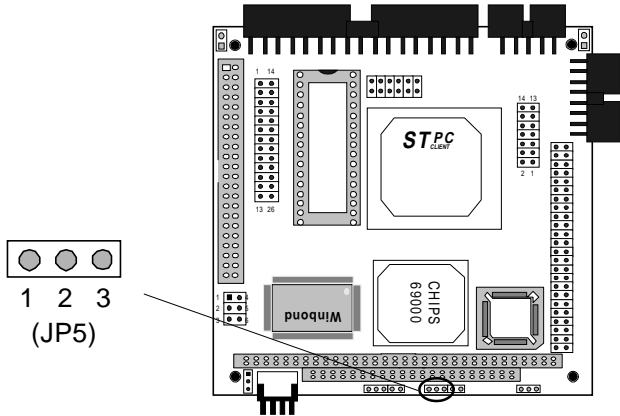

## LCD driving voltage select (JP5)

	3.3V	5V
JP5		

## Reset switch (JP6)

You can connect an external switch to easily reset your computer. This switch restarts your computer as if you had turned off the power then turned it back on. The following table shows the pin assignments for the JP6.

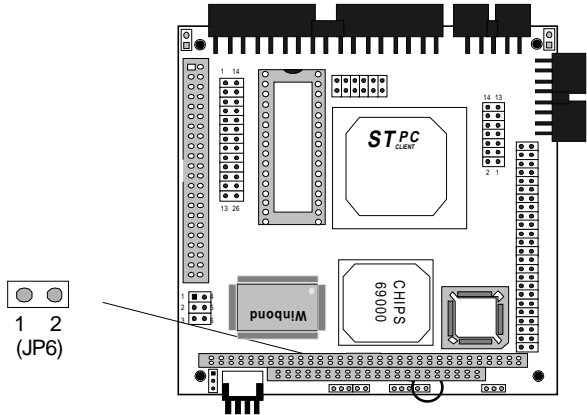

---

### Reset switch (JP6)

---

Pin	Function
1	GND
2	Reset

---

# LCD signal select (JP7)

You can select the LCD control signal by setting (JP7). The following charts show the available option:

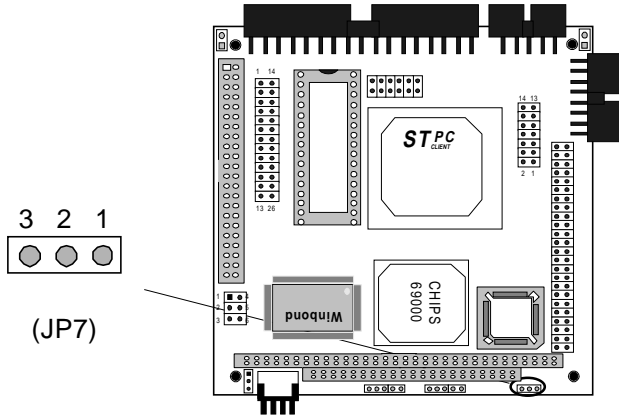

## LCD signal select (JP7)

	SHF CLK	ASHF CLK
JP7		

# External speaker connector (SP1)

You can connector an external speaker to SP1.

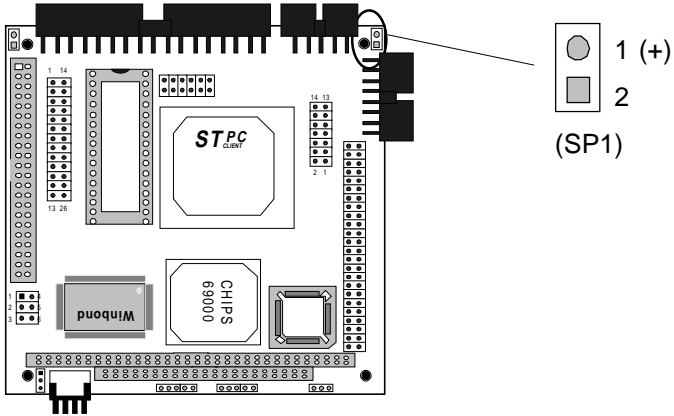



## **Flat Panel/CRT Controller Display Drivers and Utilities**

This chapter provides information about:

- Driver types and installation

# Software drivers

---

This chapter describes the operation and installation of the display drivers supplied on the *Supporting CD-ROM* that are shipped with your product.

The onboard VGA adapter is based on the CHIPS VGA Flat Panel/CRT controller and is fully IBM VGA compatible. This controller offers a large set of extended functions and higher resolutions. If you intend to use your VGA adapter in standard VGA modes only, you do not need to install any of these drivers. Since your VGA adapter is fully compatible, it does not require any special drivers to operate in standard modes.

The purpose of the enclosed software drivers is to take advantage of the extended features of the CHIPS VGA Flat Panel/CRT controller.

## Hardware configuration

Some of the high-resolution drivers provided in this package will work only in certain system configurations. If a driver does not display correctly, try the following:

1. Change the display controller to CRT-only mode, rather than flat panel or simultaneous display mode. Some high-resolution drivers will display correctly only in CRT mode.
2. If a high-resolution mode is not supported on your system, try using a lower-resolution mode. For example, 1024 x 768 mode will not work on some systems, but 800 x 600 mode is supported on most.

## Necessary prerequisites

The instructions in this manual assume that you understand elementary concepts of MS-DOS and the IBM Personal Computer. Before you attempt to install any driver from the *Supporting CD-ROM*, you should:

- Know how to copy files from a CD-ROM to a directory on the hard disk
- Understand the MS-DOS directory structure

If you are uncertain about any of these concepts, please refer to the DOS or OS/2 user reference guides for more information *before* you proceed with the installation.

## Before you begin

Make sure you know the version of the application for which you are installing drivers. The *Supporting CD-ROM* contain drivers for several versions of certain applications. For your driver to operate properly, you must install the driver for your version of the application program.

# Windows® 95

These drivers are designed to work with Microsoft® Windows®. You just install these drivers through the Windows® operating system.

## Driver installation

1. Install Windows® 95 as you normally would for a VGA display. Click the **Start** button, go to **Settings** and click on **Control Panel**. Choose the **Display** icon and double click on the icon. In the *Display Properties* window, show as figure 1:



figure 1

Click the setting button, then click the Advanced Properties icon into the *Advanced Display properties* windows, show as figure2:



figure 2

click on **Change Display Type**. In the *Change Display Type* window, click on the **Change** button under Adapter Type into the select Device window show as figure(3):This will bring up the *Select Device* window.



figure 3

2. Place the *Supporting CD-ROM* in your CD-ROM drive.

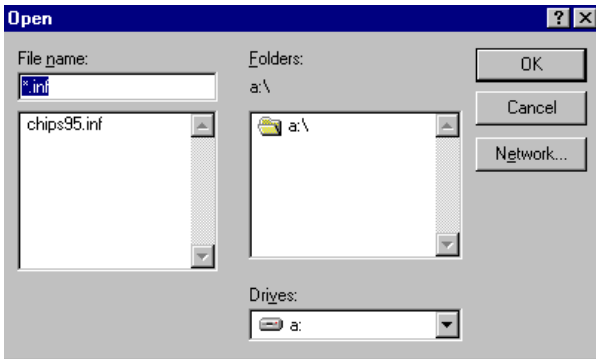

**figure 4**

In the *Select Device* window, click on **Have Disk**, Select **Browse**, and find the Win95 driver "chips95.inf" in the *Supporting CD-ROM*:

cd-rom: \CD ROM\mode name\driver\yga driver  
          \win95\chips95.inf and then click OK.

"**cd-rom**" : the drive letter of your CD-ROM drive

"**model name**" : the model number of your product

The name of the *Chips And Techn "69000 PCI "* driver will appear highlighted in the *Models* list boxflow as figure. Click OK to start the driver installation show as figure 5:

3.



**figure 5**



Once the installation is complete, the *Advanced display Properties* window will reappear. Show as figure 6:

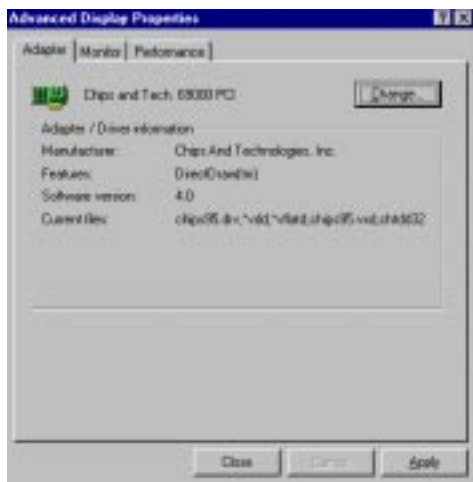

figure 6

Click on close to close the window. Then the *Display Properties* window will reappear. Show as figure 7:



figure 7

Click on **Apply**. Restart the system for the new settings to take effect, show as figure 8:

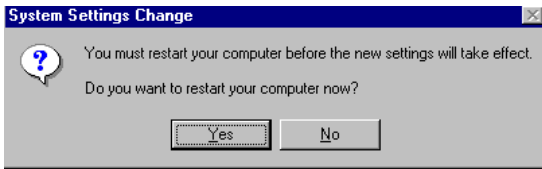

**figure 8**

# Windows® 3.1

---

These drivers are designed to work with Microsoft Windows Version 3.1. You should install these drivers through Windows.

## Driver installation

1. Install Windows as you normally would for a VGA display. Run Windows to make sure that it is working correctly.
2. Place the *Supporting CD-ROM* into your CD-ROM drive. In Windows Program Manager, choose *File* from the Options Menu. Then from the pull-down menu, choose *Run*. At the Command Line prompt, type.

```
cd-rom:\CD ROM\model name\driver\vga driver\win31\setup.exe
```

Press the <ENTER> key or click OK to begin the installation.

"**cd-rom**" : the drive letter of your CD-ROM drive

"**model name**" : the model number of your product

At this point the setup program locates the directory where Windows is installed. **For proper operation, the drivers must be installed in the Windows subdirectory.**

3. Press <ENTER> to complete the installation. Once completed, you can find the icon Chips CPL under the Control Panel. The icon allows you to select and load the installed drivers.

## OS/2

---

These drivers are designed to function with the OS/2 Version 4.0, 3.0 and 2.11 operating systems.

To install this driver, do the following steps:

1. Open an OS/2 full screen or windowed session.
2. Place the *Supporting CD-ROM* into your CD-ROM drive.
3. At the OS/2 command prompt, type the following commands to copy the files to the OS/2 drive:

Type cd-rom drive:\CD ROM\model name\driver\vga driver\os2\

When the Setup Program is completed, you will need to perform a shutdown and then restart the system in order for changes to take effect.

"**cd-rom**" : the drive letter of your CD-ROM drive

"**model name**" : the model number of your product

A log of the information output during the install can be found in <root>:\OS2\INSTALL\DISPLAY.LOG

4. After restarting the system, perform the following steps:
  1. Open the OS/2 System folder.
  2. Open the System Setup folder.
  3. Open the Display Driver Install Object.

This step will execute the Display Driver Installation (DSPINSTL) utility program to finish installation of the new drivers.

4. When the Display Driver Install window appears, select Primary Display and then select OK.
5. When the Primary Display Driver List window appears, select "Chips and Technologies 69000" from the list of adapter types, then select OK or install the video driver.

6. When the installation is complete, you will need to shut down and then restart the system for the changes to take effect. Make sure to remove the installation diskette before restarting the system.

# Windows® NT 3.51

---

These drivers are designed to work with Microsoft® Windows®.

## Driver installation

1. Install Windows® NT 3.51 as you normally would for a **VGA** display. Run Windows® NT Control Panel from the Main Group. Choose the **Display** option. In the *Display Settings* dialog box, click on *Change Display Type*. Click on **Change** from the Adapter Type in the Display Type dialog box. Click on **Other** in the *Select Device* dialog box.

2. Place the *Supporting CD-ROM* into your CD-ROM drive.

and type:

```
cd-rom: \CD ROM\model name\drive\vga drive\  
win98 nt\windows.nt\nt351\Oemsetup.inf
```

"**cd-rom**" : the drive letter of your CD-ROM drive

"**model name**" : the model number of your product

Select the adapter "Chips and Tech 69000PCI" and click OK.

Click on Install to install the selected driver. Once the installation is complete, shut down and restart the system.

# Windows® NT 4.0

---

## Driver installation

1. Install Windows<sup>®</sup> NT 4.0 as you normally would for a **VGA** display. First click the **Start** button, go to **Settings** and click on **Control Panel**. Choose the **Display** icon and click on the icon. In the **Display Properties** window, click on the Settings tab. Then click on Change Display Type. In the **Change Display Type** window, click on the **Change** button under **Adapter Type**. This will bring up the Select Device window.
2. Place the *Supporting CD-ROM* into your CD-ROM drive. In the **Select Device** window, click on **Have Disk**, select "**Browse**" and find the NT 4.0 driver from:  

```
cd-rom : \CD ROM\model name\dirver\vga driver\  
win98 nt\windows.nt\nt40\Oemsetup.inf
```

"**cd-rom**" : the drive letter of your CD-ROM drive  
"**model name**" : the model number of your product

and then click **OK**. The name of the **Chips and Technologies, Inc. Video Controller** driver will appear highlighted in the Modules list box. Select Chips and Tech. 69000 and Click **OK**. Click **OK** to start the driver installation.
3. Once the installation is complete, the **Change Display Type** window will reappear. Click on close to close the window. Then the **Display Properties** window will reappear. Click on **Apply**. Restart the system for the new settings to take effect.



APPENDIX

**A**

## **Watchdog Timer**

# Watchdog Timer

---

You have to set Watching Dog Function is Enable in BIOS CMOS Setup before use this function.

Set Watching Dog Timer Output Function Active or Inactive.

Logical Device 7 : Register number 30 (CR30)

00h : Function inactive

01h : Function active

Write Watching Dog Timer Time-out value.

Logiceal Device 8 : Register number F2 (CRF2)

00h : Time-out Disable

01h : Time-out occurs after 16 seconds

02h : Time-out occurs after 46 seconds

03h : Time-out occurs after 1 minute 16 seconds

04h : Time-out occurs after 1 minute 46 seconds

05h : Time-out occurs after 2 minutes 16 seconds

.....

FFh : Time-out occurs after 127 minutes 16 seconds

program chip basic procedure is :

1. Enter configuration mode.
2. Select Logical Device.
3. Select register number.
4. write/read data to/from register.
5. exit configuration mode.

watch-dog function program procedure is :

1. Active Watching-Dog Timer output Function.
2. Write Watching Dog Timer Time-out value.

## Example :

Following is an Example of programming 16 seconds period for watchdog timer in assembly language. When timer times out, it will generate system reset.

```
.model small
.code
CONFIG_PORT    dw  3f0h
DATA_PORT      dw  3f1h
SetWatchDog_Time PROC
    push  bx
    push  cx
    push  dx
    mov  bl,7      ;; Select Logical Device Number 7
    mov  ax,0130h  ;; Register 30h write 01h to Active Function
    call W977Write ;;
    mov  bl,8      ;; Select logical Device Number 8
    mov  ax,01f2h  ;; Register F2h write Time-out value (01h)
    call W977Write ;; watchdog time-out value is 16 sec
    pop  dx
    pop  cx
    pop  bx
    mov  ah,4ch
    int  21h
    ret
```

## **SetWatchDog\_Time ENDP**

;; Enter to I/O Chip Program Configuration Register Mode

EnterConfig proc

```
cli
push ax
push dx
mov al,87h      ;; Specific Value to Enter Config Mode
mov dx,cs:CONFIG_PORT ;;
out dx,al      ;; Write to Config Port Twice!
out dx,al      ;;
jmp $+2        ;; Delay
jmp $+2        ;;
pop dx
pop ax
ret
```

EnterConfig endp

;; Exit to I/O Chip Program Configuration Register Mode

ExitConfig proc

```
push ax
push dx
mov al,0aah     ;; Specific Value to Exit Config Mode
mov dx,cs:CONFIG_PORT ;;
out dx,al      ;; Write to Config Port
pop dx
pop ax
ret
```

ExitConfig endp

```

;; Select The I/O Chip Program Configuration Register Logical Device
;; Input : bl = logical device number
SelectDevice proc
    push  ax
    push  dx
    mov   al,07h          ;; Select Control Register 7 (CR07)
    mov   dx,cs:CONFIG_PORT ;;
    out   dx,al          ;; Write to Config Port
    jmp  $+2
    mov   al,bl          ;; Write Logical Device Number
    mov   dx,cs:DATA_PORT  ;; to Data Port
    out   dx,al
    pop   dx
    pop   ax
    ret
SelectDevice endp

```

```

;; Setting I/O Chip Program Configuration Register Value
;; Input : al = register number
;;      ah = setting value
W977Write PROC
    push  dx
    call  EnterConfig    ;; Enter Config Mode
    call  SelectDevice   ;; Select Logical Device
    mov   dx,cs:CONFIG_PORT ;; Write value(al) to Config Port
    out   dx,al          ;; to select register number
    mov   al,ah
    mov   dx,cs:DATA_PORT  ;; Write data(ah) to Data Port
    out   dx,al          ;; to setting register value
    call  ExitConfig     ;; Exit Config Mode
    pop   dx
    ret
W977Write ENDP
end

```

APPENDIX

# B

## **Installing PC/104 Modules**

This appendix gives instructions for installing PC/104 modules.

## Installing PC/104 modules

---

The PCM-4335's PC/104 connectors give you the flexibility to attach PC/104 expansion modules. These modules perform the functions of traditional plug-in expansion cards, but save space and valuable slots. Modules include:

- **PCM-3110B** PCMCIA Module (one-slot)
- **PCM-3115B** PCMCIA Module (two-slot)
- **PCM-3200** PC/104 Sound Module
- **PCM-3420** PC/104 Fast SCSI Module
- **PCM-3521** Advanced Flat-Panel/CRT VGA Module
- **PCM-3522** LCD Panel Adapter
- **PCM-3600** PC/104 Fax/Modem Module
- **PCM-3610** Isolated RS-232 and RS-422/485 Module
- **PCM-3640** PC/104 4-port RS-232 Module
- **PCM-P50** PC/104 Vehicle Power Supply
- **PCM-3660** Ethernet Module
- **PCM-3718** 30 KHz A/D Module
- **PCM-3724** 48-channel DIO Module
- **PCM-3910** Breadboard Module
- **PCM-3810** Solid State Disk Module
- **PCM-3820** High Density Flash Solid State Disk Module



Installing these modules on the PCM-4335 is a quick and simple operation. The following steps show how to mount the PC/104 modules:

- Step1 Remove the PCM-4335 from your system, paying particular attention to the safety instructions already mentioned above.
- Step2 Make any jumper or link changes required to the CPU card now. Once the PC/104 module is mounted, you may have difficulty in accessing these.
- Step3 Mount the PC/104 module onto the CPU card. Do this by pressing the module firmly but carefully onto the mounting connectors.
- Step4 Secure the PC/104 module onto the CPU card using the four mounting spacers and screws.

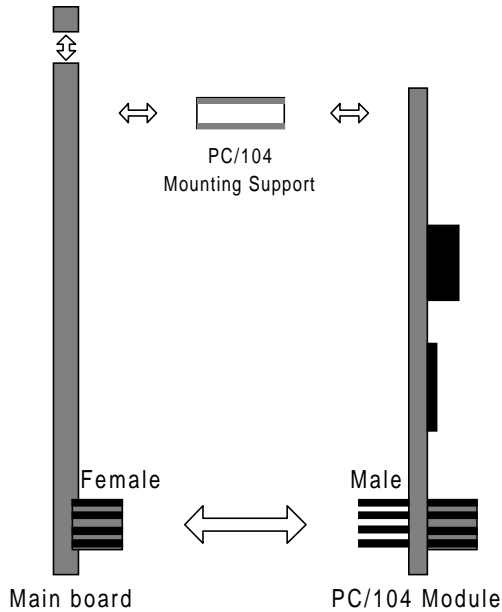

**PC/104 Module Mounting Diagram**

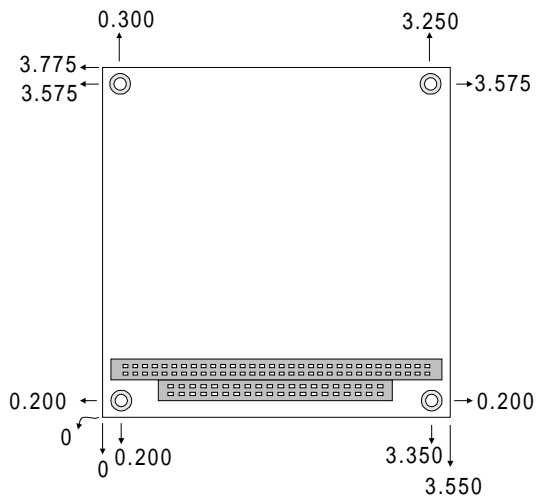

**PC/104 module dimenstions (inches  $\pm 5\%$ )**