

Our Products Make Your Product Better®

To learn more about EMAC's products and services and how they can help your project

http://ftp.emacinc.com/Tech_Info/About_EMAC_Products_and_Services.pdf



Authorized Distributor, Integrator, and Value-Added Reseller

Manual downloaded from <ftp.emacinc.com>

For purchase information please contact info@emacinc.com

For technical support please submit a ticket at www.emacinc.com/support

HSB-440I

Half Size CPU Card
STPC Atlas SoC 133MHz
With LCD, Ethernet,
Two USB Ports

Copyright Notice

This document is copyrighted, 2004. All rights are reserved. The original manufacturer reserves the right to make improvements to the products described in this manual at any time without notice.

No part of this manual may be reproduced, copied, translated, or transmitted in any form or by any means without the prior written permission of the original manufacturer. Information provided in this manual is intended to be accurate and reliable. However, the original manufacturer assumes no responsibility for its use, or for any infringements upon the rights of third parties that may result from its use.

The material in this document is for product information only and is subject to change without notice. While reasonable efforts have been made in the preparation of this document to assure its accuracy, we assume no liabilities resulting from errors or omissions in this document, or from the use of the information contained herein.

We reserve the right to make changes in the product design without notice to its users.

Acknowledgments

All other products' name or trademarks are properties of their respective owners.

- Award is a trademark of Award Software International, Inc.
- CompactFlash™ is a trademark of the Compact Flash Association.
- STPC® is trademarks of STMicroelectronics.
- DOC2000® is a registered trademark of M-System Co., Ltd
- Microsoft Windows® is a registered trademark of Microsoft Corp.
- VGA® is a registered trademark of IBM Corp.
- Winbond is a trademark of Winbond Electronic Corp.

Packing List

Before you begin installing your card, please make sure that the following materials have been shipped:

- 1 HSB-440I Half-size CPU Card
- 1 Quick Installation Guide
- 1 CD-ROM for manual (in PDF format) and drivers
- 1 HDD Cable
- 1 FDD Cable
- 1 Short-copper and support
- 1 Y-Cable (Keyboard and Mouse)
- 1 Parallel Port and Serial port cable with bracket
- 1 Dual Serial port cable with bracket
- 1 Jumper cap

If any of these items should be missing or damaged, please contact your distributor or sales representative immediately.

Contents

Chapter 1 General Information

1.1 Introduction	1-2
1.2 Features	1-3
1.3 Specifications.....	1-4

Chapter 2 Quick Installation Guide

2.1 Safety Precautions	2-2
2.2 Location of Connectors and Jumpers.....	2-3
2.3 Mechanical Drawing	2-5
2.4 List of Jumpers.....	2-7
2.5 List of Connectors.....	2-8
2.6 Setting Jumpers.....	2-9
2.7 LCD Voltage Selection (JP1).....	2-10
2.8 TTL-LCD Clock Selection (JP2).....	2-10
2.9 Onboard COM Port on/Off Selection (JP3).....	2-10
2.10 Clear CMOS (JP4).....	2-11
2.11 COM2 RS-232/422/485 Selection (JP5 & JP7).....	2-11
2.12 DiskOnChip 2000 Address Selection (JP6).....	2-11
2.13 Front Panel Connector (CN1).....	2-12
2.14 LPT Port Connector (CN2).....	2-12
2.15 TTL LCD Connector (CN3).....	2-13
2.16 AT Power Connector (CN4).....	2-14
2.17 COM3/COM4 RS-232 Serial Port.....	2-14

2.18 Digital I/O Connector (CN7).....	2-15
2.19 USB Connector (CN8).....	2-15
2.20 COM2 RS-232/422/485 Serial Port.....	2-16
2.21 Internal Mouse Connector (CN10).....	2-16
2.22 Internal Keyboard Connector (CN11).....	2-16
2.23 IrDA Connector (CN12).....	2-17
2.24 PS2 Keyboard/ Mouse Connector (CN13).....	2-17
2.25 4P Power Connector(CN14).....	2-18
2.26 3P Power Connector (CN15).....	2-18
2.27 Floppy Connector (FDD1).....	2-18
2.28 EIDE Connector (HDD1).....	2-19
2.29 VGA Display Connector (VGA1).....	2-20
2.30 COM1 RS-232 Serial Port Connector (COM1).....	2-21
2.31 10/100Base-Tx Ethernet Connector (LAN1).....	2-21

Chapter 3 Award BIOS Setup

3.1 System Test and Initialization.....	3-2
3.2 Award BIOS Setup.....	3-3
3.3 Standard CMOS Feture.....	3-5
3.4 Advanced BIOS Features.....	3-6
3.5 Advanced Chipset Features.....	3-7
3.6 Integrated Peripherals.....	3-8
3.7 Power management setup.....	3-9
3.8 PnP/PCI configuration.....	3-10
3.11 Load Fail-Safe defaults.....	3-11
3.12 Load Optimized defaults.....	3-11

3.13 Set password..... 3-11

3.14 Save & Exit setup..... 3-12

3.15 Exit without saving..... 3-12

Appendix A Programming the WatchDog Timer

A.1 Programming the watchdog timer.....A-2

Appendix B CFD Cover Installation Guide

B.1 How to install the CompactFlash coverB-2

B.2 How to disassemble the CompactFlash coverB-6

Chapter

1

**General
Information**

1.1 Introduction

HSB-440I is a half-size ISA bus CPU card with STPC Atlas low power consumption single chip solution. This single chip integrated many kinds of functions like: processor, graphic controller (with LCD interface), PCI bridge, and simple super I/O.

Fanless and Low power Consumption Design

With our HSB-440I half-size CPU card, the STPC Atlas 133 MHz low power consumption CPU has been specially designed to work well in environments with temperatures of up to 60 without the cooling fan. Eliminating the CPU cooling fan from a system significantly reduces MTBF worries and increases application possibilities.

Easy Installation Process

From now on, the system engineers will be able to upgrade their 386-based systems to 486 level without as many worries, because with HSB-440I a 486 level STPC Atlas processor is mounted directly on board. It eases the configuration and installation process because the system engineers don't have to set any jumpers for speed or voltage difference between various CPUs.

Networking

Targeting on the rapid growing networking and embedded system markets, the HSB-440I integrates a PCI-bus Realtek RTL8139DL 10/100 Base-Tx Ethernet controller. Running on the STPC Atlas low power consumption CPU, it also ideal for the demanding Internet Access Devices or Mobile Applications that require a low power consumption and low heat dissipation SBC.

Others

Other impressive features include a PC/104 expansion connector is provided, a built-in 18bit TFT LCD interface, a 32-pin M-Systems DiskOnChip socket supports Flash memory capacity from 8MB to 1 GB, a Compact Flash card connector, four serial ports, one parallel port, and IrDA support.

1.2 Features

- Supports STPC Atlas SoC 133MHz (BGA)
- Integrated LCD controller supports 18-bit TFT panel
- 10/ 100Mbps high speed Ethernet
- Supports DiskOnChip 2000 socket and Compact Flash Type
- IrDA transmission
- Expansion ISA interface
- Support PC/104 socket
- Fanless and +5V active
- Watchdog & Digital I/O

Note: TFT resolution only supports 640 x 480 and 800 x 600 (default). If you want to change the resolution, please visit our website (www.emacinc.com) and download the BIOS.

1.3 Specifications

System

- CPU: STPC Atlas SoC 133MHz
- I/O Chipset: STPC Atlas + Winbond 83977F
- System Memory: Onboard 64MB memory
- VGA/LCD Controller: STPC Atlas, Share up to 4MB, LCD Support VGA/SVGA 18bit TFT, CRT Support VGA/SVGA/XGA. (Not support full screen scaling)
- Ethernet: One LAN, Use External RJ-45 Connector
Realtek 8139DL 10/ 100Mbps LAN chips x 1
- BIOS: Award Plug & Play ISA BIOS – 2Mb ROM
- IDE Interface: PIO-Mode 4 x 1 channel (Support two ATAPI devices)
- Floppy Drive Interface: One Standard FDD port, support up to two floppy devices
- Serial Port: Four COM ports : (Three internal pin headers, One external on bracket)
COM 1/3/4 : RS-232
COM2: RS232/RS-422/RS-485

- Digital I/O Digital I/O, 8-In, 8-Out
- Parallel Port Supports SPP/EPP/ECP mode
- K/B and Mouse One Mini-DIN PS/2 keyboard and Mouse connector
One internal keyboard pin header
One internal mouse pin header
- Universal Serial Bus Two USB Port (One 5x2 pin header)
- Disk On Chip/
Compact Flash Supports DOC 2000 Socket
Support CF type Slot (USED IDE Secondary Interface)
- PC/104 Module Support PC/104 Slot
- Expansion Interface ISA Interface
- IR Interface Supports One IrDA header (only in Windows OS environment)
- Watchdog timer: Can generate a system reset.
Software selectable time-out interval (15sec~127min15sec, 30sec/step)
- RTC Internal RTC
- Operation Temp. 0 ~ 60

Chapter

2

Quick Installation Guide

Notice:

The Quick Installation Guide is derived from Chapter 2 of user manual. For other chapters and further installation instructions, please refer to the user manual CD-ROM that came with the product.



2.1 Safety Precautions

Warning!

Always completely disconnect the power cord from your board whenever you are working on it. Do not make connections while the power is on, because a sudden rush of power can damage sensitive electronic components.

Caution!

Always ground yourself to remove any static charge before touching the board. Modern electronic devices are very sensitive to static electric charges. Use a grounding wrist strap at all times. Place all electronic components on a static-dissipative surface or in a static-shielded bag when they are not in the chassis

2.2 Location of Connectors and Jumpers

Component side

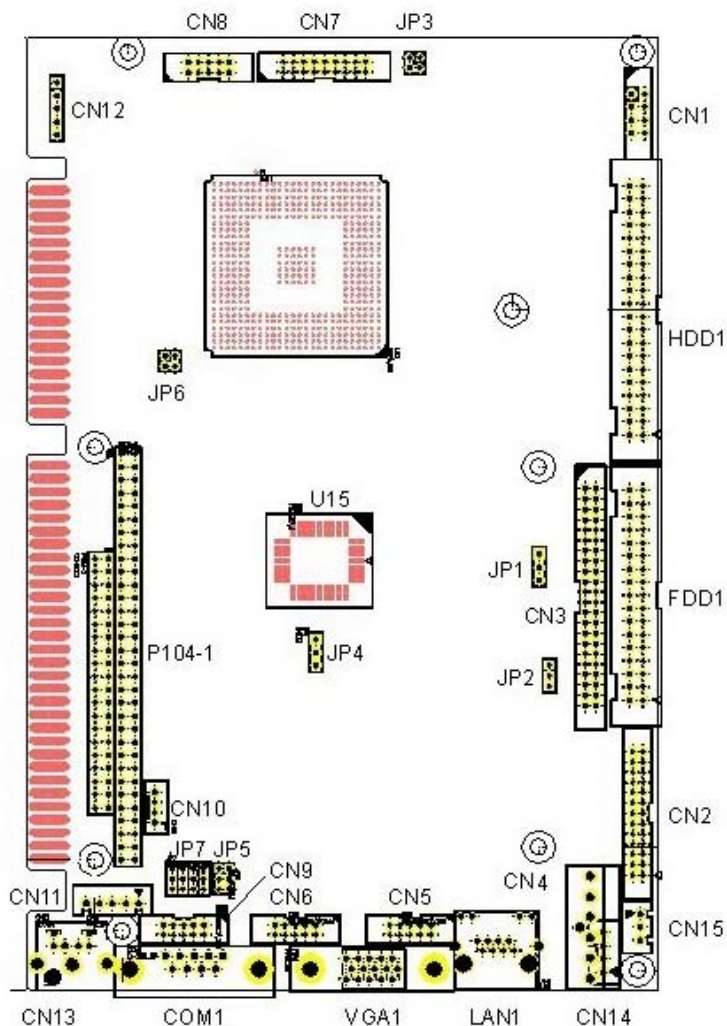

Solder side

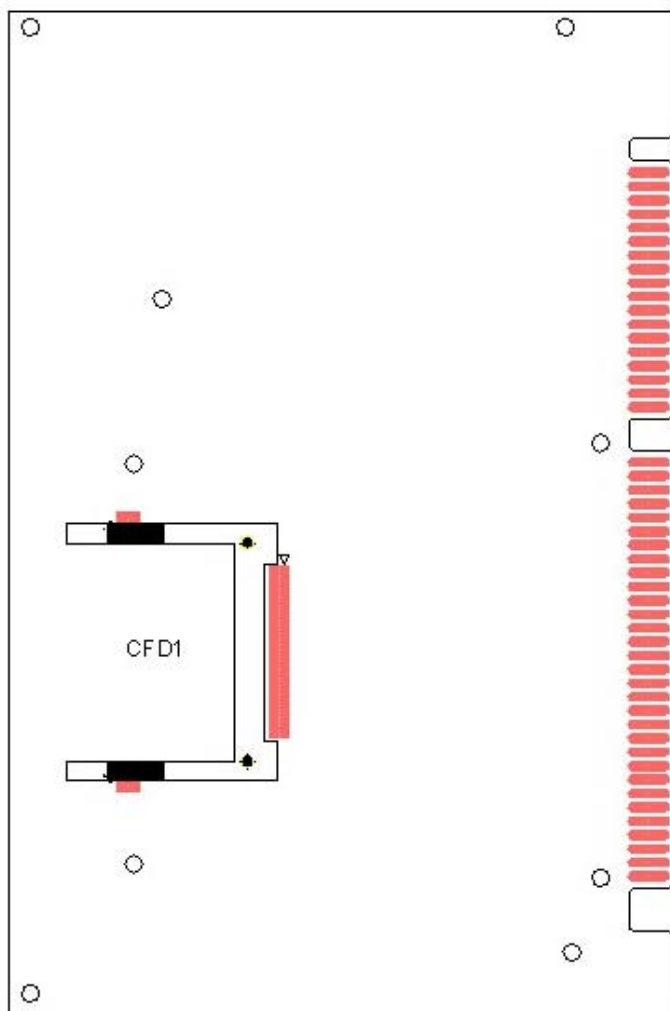

2.3 Mechanical Drawing

Component side

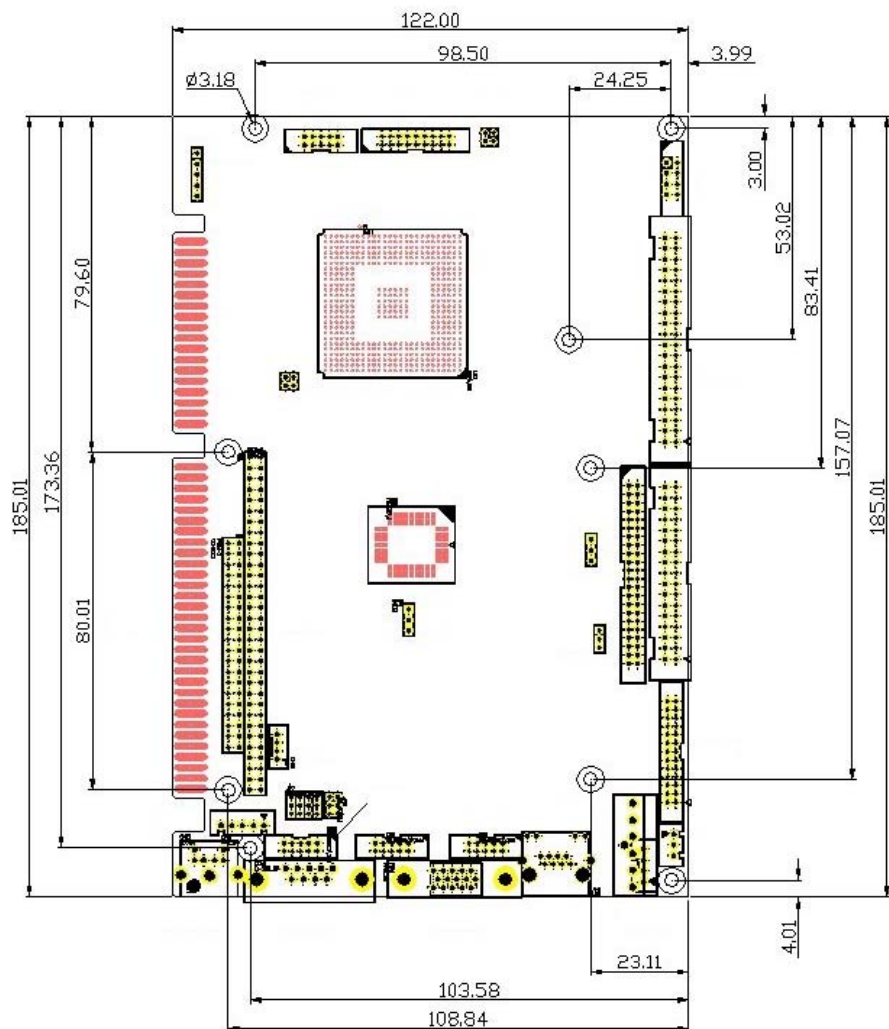

Solder side

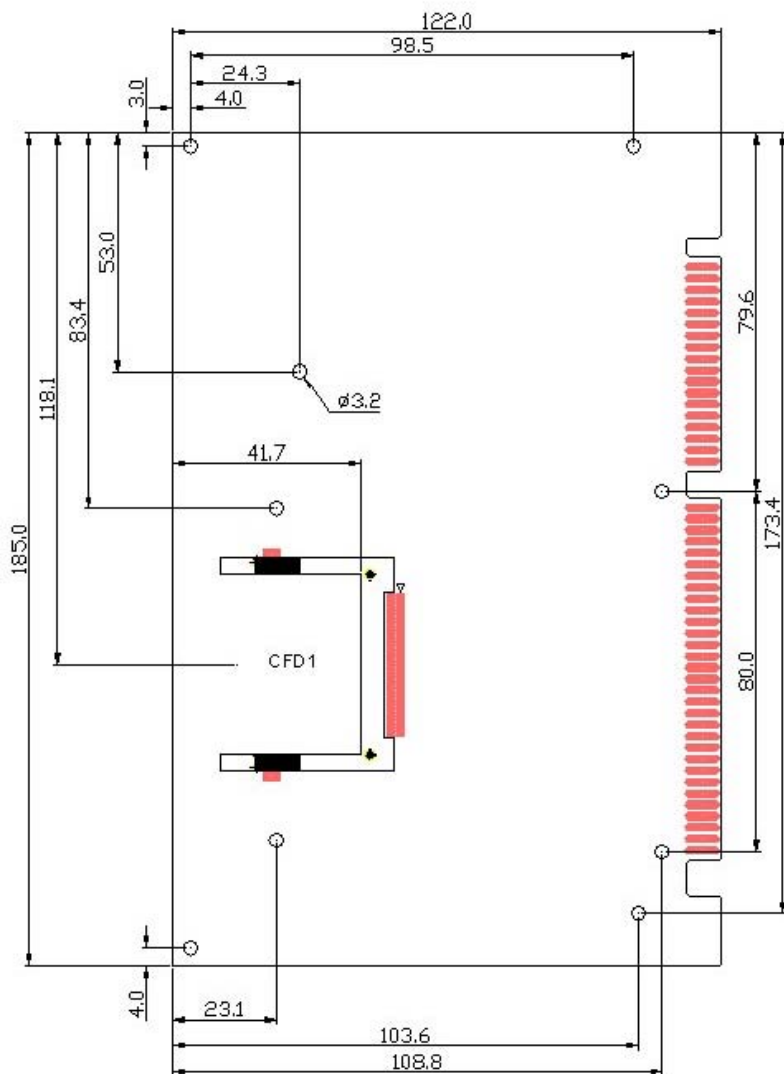

Bracket Side

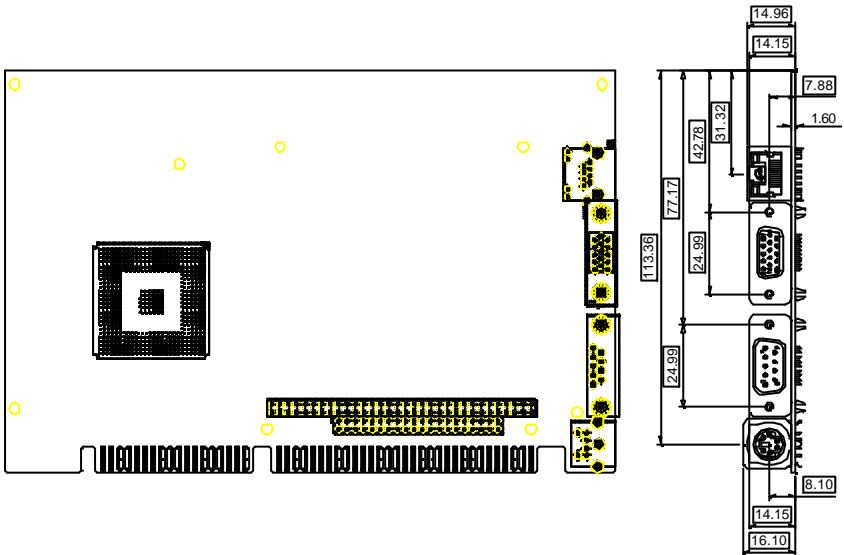

2.4 List of Jumpers

The board has a number of jumpers that allow you to configure your system to suit your application.

The table below shows the function of each of the jumpers of the board:

Jumpers

Label	Function
JP1	LCD Voltage Selection
JP2	TTL-LCD Clock Selection
JP3	Onboard COM Port On/Off Selection
JP4	Clear CMOS
JP5	COM2 RS-232/422/485 Selection
JP6	DiskOnChip 2000 Address Selection
JP7	COM2 RS-232/422/485 Selection

2.5 List of Connectors

The board has a number of connectors that allow you to configure your system to suit your application.

The table below shows the function of each of the connectors of the board:

Connectors

Label	Function
CN1	Front Panel Connector
CN2	LPT Port Connector
CN3	TTL_LCD Connector
CN4	Power Connector
CN5	COM3 RS-232 Serial Port Connector
CN6	COM4 RS-232 Serial Port Connector
CN7	Digital I/O Connector
CN8	USB Connector
CN9	COM2 RS-232/422/485 Serial Port Connector
CN10	Internal Mouse Connector
CN11	Internal Keyboard Connector
CN12	IrDA Connector
CN13	PS2 Keyboard/Mouse Connector
CN14	4P Power Connector
CN15	3P Power Connector
FDD1	Floppy Connector
HDD1	EIDE Connector
VGA1	VGA Display Connector
COM1	COM1 RS-232 Serial Port Connector
LAN1	10/100 Base-Tx Ethernet Connector
CFD1	CompactFlash Slot
P104-1	PC/104 Connector

2.6 Setting Jumpers

You configure your card to match the needs of your application by setting jumpers. A jumper is the simplest kind of electric switch. It consists of two metal pins and a small metal clip (often protected by a plastic cover) that slides over the pins to connect them. To “close” a jumper you connect the pins with the clip.

To “open” a jumper you remove the clip. Sometimes a jumper will have three pins, labeled 1, 2 and 3. In this case you would connect either pins 1 and 2 or 2 and 3.

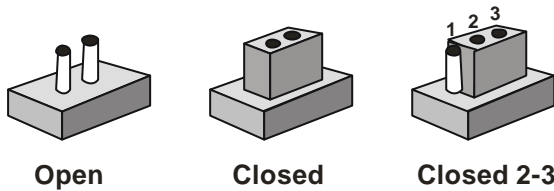

A pair of needle-nose pliers may be helpful when working with jumpers.

If you have any doubt about the best hardware configuration for your application, contact your local distributor or sales representative before you make any change.

Generally, you simply need a standard cable to make most connections.

2.7 LCD Voltage Selection (JP1)

JP1	Function
1-2	+5V
2-3	+3.3V (Default)

2.8 TTL-LCD Clock Selection (JP2)

JP2	Function
1-2	Reverse Clock
2-3	Clock (Default)

2.9 Onboard COM Port On/Off Selection (JP3)

JP3	Function
-	COM1, COM2 enable (Default)
1-2	COM1 Disable
3-4	COM2 Disable

2.10 Clear CMOS (JP4)

Warning:

To avoid damaging the computer, always turn off the power supply before setting "Clear CMOS." Before turning on the power supply, set the jumper back to "Normal"

JP4	Function
1-2	Normal (Default)
2-3	Clear CMOS

2.11 COM2 RS-232/422/485 Selection (JP5&JP7)

JP5	JP7	Function
1-2	1-2, 4-5, 7-8, 10-11	RS-232 (Default)
3-4	2-3, 5-6, 8-9, 11-12	RS-422
5-6	2-3, 5-6, 8-9, 11-12	RS-485

2.12 DiskOnChip2000 Address Selection (JP6)

JP6	Function
1-2, 3-4	Disable
1-2	DC00
3-4	D800 (Default)
-	D400

2.13 Front Panel Connector (CN1)

Pin	Signal	Pin	Signal
1	IDE LED(-)	2	IDE LED(+)
3	External Buzzer(-)	4	External Buzzer(+)
5	Power LED(-)	6	Power LED(+)
7	Reset Switch(-)	8	Reset Switch(+)

2.14 LPT Port Connector (CN2)

Pin	Signal	Pin	Signal
1	#STROBE	2	#AFD
3	DATA0	4	#ERROR
5	DATA1	6	#INIT
7	DATA2	8	#SLIN
9	DATA3	10	GND
11	DATA4	12	GND
13	DATA5	14	GND
15	DATA6	16	GND
17	DATA7	18	GND
19	#ACK	20	GND
21	BUSY	22	GND
23	PE	24	GND
25	SELECT	26	N.C

2.15 TTL_LCD Connector (CN3)

Pin	Signal	Pin	Signal
1	+12V	2	+12V
3	GND	4	GND
5	LCD VCC (by JP1)	6	LCD VCC (by JP1)
7	N.C.	8	GND
9	GND	10	GND
11	BLUE0	12	BLUE1
13	BLUE2	14	BLUE3
15	BLUE4	16	BLUE5
17	GND	18	GND
19	GREEN0	20	GREEN1
21	GREEN2	22	GREEN3
23	GREEN6	24	GREEN5
25	GND	26	GND
27	RED0	28	RED1
29	RED2	30	RED3
31	RED4	32	RED5
33	GND	34	GND
35	DOT_CLOCK	36	VSYNC
37	DE	38	HSYNC
39	GND	40	ENAVEE
41	GND	42	GND
43	GND	44	GND

2.16 AT Power Connector (CN4)

Pin	Signal
1	N.C
2	+5V
3	+12V
4	-12V
5	GND
6	GND

2.17 COM3/COM4 RS-232 Serial Port Connector (CN5&CN6)

Pin	Signal	Pin	Signal
1	DCD	2	RXD
3	TXD	4	DTR
5	GND	6	DSR
7	RTS	8	CTS
9	RI	10	N.C

2.18 Digital I/O Connector (CN7)

Master Address is 326 with control pin 1, 3, 5 ~, 15

Slave Address is 32E with control pin 2, 4, 6, ~, 16

Pin	Signal	Pin	Signal
1	GPIO 0	2	GPIO 8
3	GPIO 1	4	GPIO 9
5	GPIO 2	6	GPIO 10
7	GPIO 3	8	GPIO 11
9	GPIO 4	10	GPIO 12
11	GPIO 5	12	GPIO 13
13	GPIO 6	14	GPIO 14
15	GPIO 7	16	GPIO 15
17	GND	18	+5V

2.19 USB Connector (CN8)

Pin	Signal	Pin	Signal
1	+5V	2	GND
3	USBD1-	4	GND
5	USBD1+	6	USBD2+
7	GND	8	USBD2-
9	GND	10	+5V

2.20 COM2 RS-232/422/485 Serial Port Connector (CN9)

Pin	Signal	Pin	Signal
1	DCD(422TXD-/485DATA-)	2	RXD(422RXD+)
3	TXD(422TXD+/485DATA+)	4	DTR(422RXD-)
5	GND	6	DSR
7	RTS	8	CTS
9	RI	10	N.C

2.21 Internal Mouse Connector (CN10)

Pin	Signal
1	MS_CLK
2	MS_DATA
3	GND
4	+5V

2.22 Internal Keyboard Connector (CN11)

Pin	Signal
1	KB_CLK
2	KB_DATA
3	N.C
4	GND
5	+5V

2.23 IrDA Connector(CN12)

Pin	Signal
1	+5V
2	N.C
3	IRRX
4	GND
5	IRTX

2.24 PS2 Keyboard/Mouse Connector (CN13)

Pin	Signal
1	KB_DATA
2	MS-DATA
3	GND
4	+5V
5	KB_CLK
6	MS_CLK

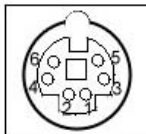

2.25 4P Power Connector (CN14)

Pin	Signal
1	+5V
2	GND
3	GND
4	+12V

2.26 3P Power Connector (CN15)

Pin	Signal
1	-12V
2	-5V
3	GND

2.27 Floppy Connector (FDD1)

Pin	Signal	Pin	Signal
1	GND	2	#REDWC
3	GND	4	N.C
5	GND	6	#DS1
7	GND	8	#INDEX
9	GND	10	#MOTOR A
11	GND	12	#DRIVE SELECT B
13	GND	14	#DRIVE SELECT A
15	GND	16	#MOTOR B

17	GND	18	#DIR
19	GND	20	#STEP
21	GND	22	#WRITE DATA
23	GND	24	#WRITE GATE
25	GND	26	#TRACK0
27	GND	28	#WRITE PROTECT
29	GND	30	#READ DATA
31	GND	32	#SIDE1
33	GND	34	#DISK CHANGE

2.28 EIDE Connector (HDD1)

Pin	Signal	Pin	Signal
1	IDE RESET	2	GND
3	DATA7	4	DATA8
5	DATA6	6	DATA9
7	DATA5	8	DATA10
9	DATA4	10	DATA11
11	DATA3	12	DATA12
13	DATA2	14	DATA13
15	DATA1	16	DATA14
17	DATA0	18	DATA15
19	GND	20	N.C
21	REQ	22	GND
23	IO WRITE	24	GND
25	IO READ	26	GND
27	IO READY	28	GND
29	DACK	30	GND
31	IRQ14	32	N.C

33	ADDR1	34	N.C.
35	ADDR0	36	ADDR2
37	CS#1	38	CS#3
39	LED	40	GND

2.29 VGA Display Connector (VGA1)

Pin	Signal	Pin	Signal
1	RED	2	GREEN
3	BLUE	4	N.C
5	GND	6	GND
7	GND	8	GND
9	N.C	10	GND
11	N.C	12	DDCDAT
13	HSYNC	14	VSYNC
15	DDCCLK		

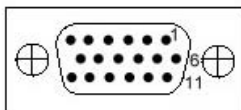

2.30 COM1 RS-232 Serial Port Connector (COM1)

COM1 is a D-SUB connector. The table below shows its pin assignments.

Pin	Signal	Pin	Signal
1	DCD	2	RXD
3	TXD	4	DTR
5	GND	6	DSR
7	RTS	8	CTS
9	RI		

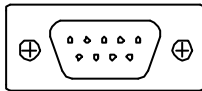

2.31 10/100Base-Tx Ethernet Connector (LAN1)

LAN1 is the RJ-45 connector based on the chipset integrated LAN. The figure below shows the pin out assignments of the connector and its corresponding input jack.

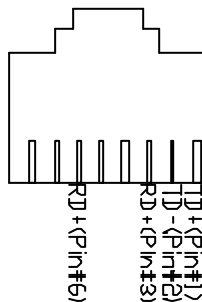

Chapter

3

**Award
BIOS Setup**

3.1 System test and initialization

These routines test and initialize board hardware. If the routines encounter an error during the tests, you will either hear a few short beeps or see an error message on the screen. There are two kinds of errors: fatal and non-fatal. The system can usually continue the boot up sequence with non-fatal errors. Non-fatal error messages usually appear on the screen along with the following instructions:

Press <F1> to RESUME

Write down the message and press the F1 key to continue the boot up sequence.

System configuration verification

These routines check the current system configuration against the values stored in the CMOS memory. If they do not match, the program outputs an error message. You will then need to run the BIOS setup program to set the configuration information in memory.

There are three situations in which you will need to change the CMOS settings:

1. You are starting your system for the first time
2. You have changed the hardware attached to your system
3. The CMOS memory has lost power and the configuration information has been erased.

The HSB-440I CMOS memory has an integral lithium battery backup for data retention. However, you will need to replace the complete unit when it finally runs down.

3.2 Award BIOS setup

Awards BIOS ROM has a built-in Setup program that allows users to modify the basic system configuration. This type of information is stored in battery-backed CMOS RAM so that it retains the Setup information when the power is turned off. Please notice that TFT resolution only supports 640 x 480 and 800 x 600 (default). If you want to change the resolution, please visit our website (www.emacinc.com) and download the BIOS.

Entering setup

Power on the computer and press immediately. This will allow you to enter Setup.

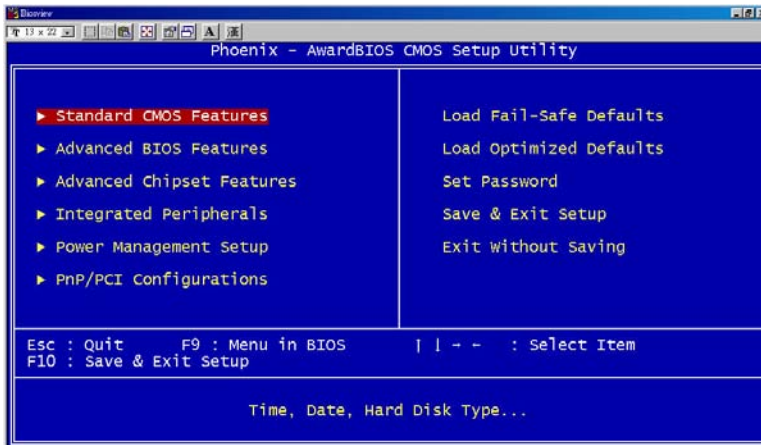

Standard CMOS Features

Use this menu for basic system configuration. (Date, time, IDE, etc.)

Advanced BIOS Features

Use this menu to set the advanced features available on your system.

Advanced Chipset Features

Use this menu to change the values in the chipset registers and optimize your system performance.

Integrated Peripherals

Use this menu to specify your settings for integrated peripherals. (Primary slave, secondary slave, keyboard, mouse etc.)

Power Management Setup

Use this menu to specify your settings for power management. (HDD power down, power on by ring, KB wake up, etc.)

PnP/PCI Configurations

This entry appears if your system supports PnP/PCI.

Load Fail-Safe Defaults

Use this menu to load the BIOS default values for the minimal/stable performance for your system to operate.

Load Optimized Defaults

Use this menu to load the BIOS default values that are factory settings for optimal performance system operations. While AWARD has designated the custom BIOS to maximize performance, the factory has the right to change these defaults to meet their needs.

Set Password

Use this menu to set Passwords.

Save and Exit Setup

Save CMOS value changes to CMOS and exit setup.

Exit Without Saving

Abandon all CMOS value changes and exit setup.

3.3 Standard CMOS Features

When you choose the Standard CMOS Features option from the INITIAL SETUP SCREEN menu, the screen shown below is displayed. This standard Setup Menu allows users to configure system components such as date, time, hard disk drive, floppy drive and display. Once a field is highlighted, on-line help information is displayed in the right box of the Menu screen.

HSB-440I

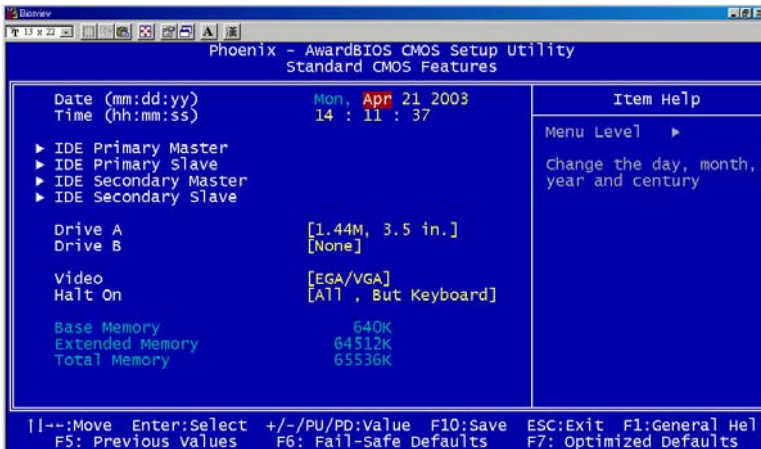

3.4 Advanced BIOS Features

By choosing the Advanced BIOS Features option from the INITIAL SETUP SCREEN menu, the screen below is displayed. This sample screen contains the manufacturer's default values for the HSB-4401.

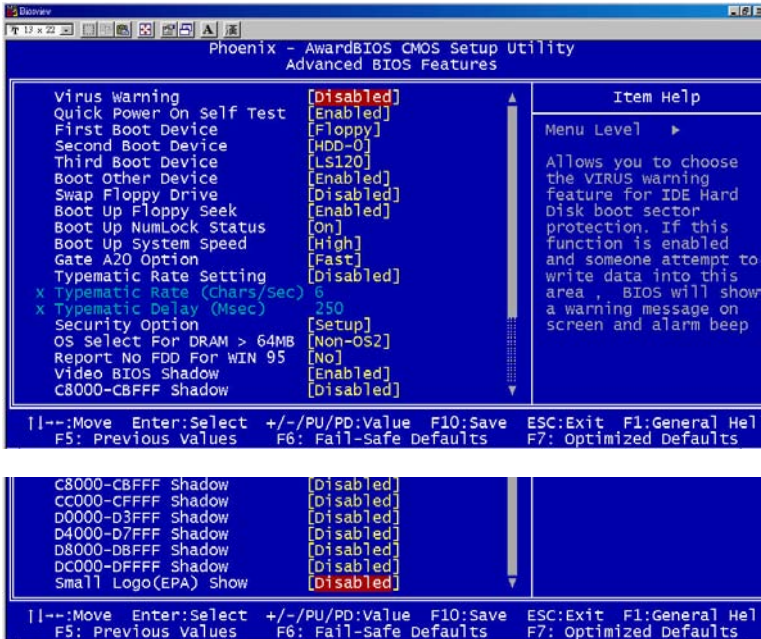

3.5 Advanced Chipset Features

By choosing the Advanced Chipset Features option from the INITIAL SETUP SCREEN menu, the screen below is displayed. This sample screen contains the manufacturer's default values for the HSB-4401.

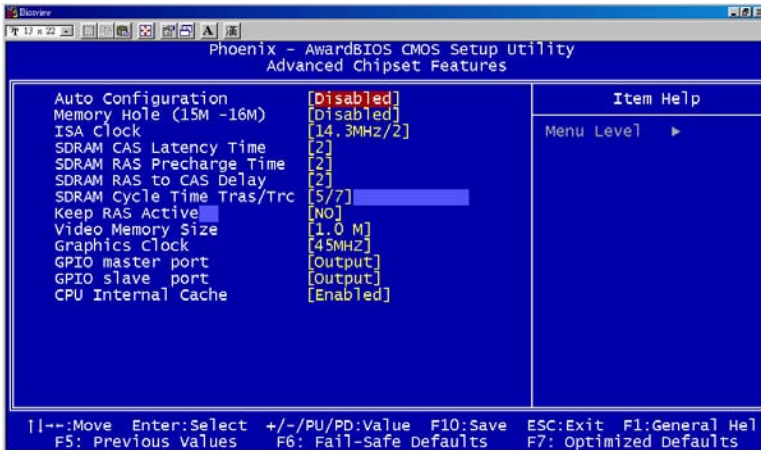

3.6 Integrated Peripherals

By choosing the Integrated Peripherals from the INITIAL SETUP SCREEN menu, the screen below is displayed. This sample screen contains the manufacturer's default values for the HSB-440I.

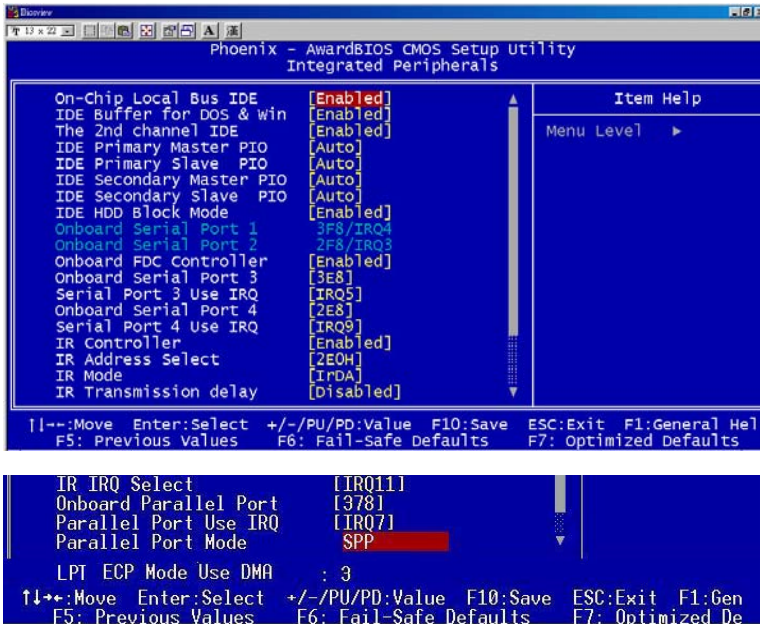

3.7 Power management setup

By choosing the Power Management Setup from the INITIAL SETUP SCREEN menu, the screen below is displayed. This sample screen contains the manufacturer's default values for the HSB-440I.

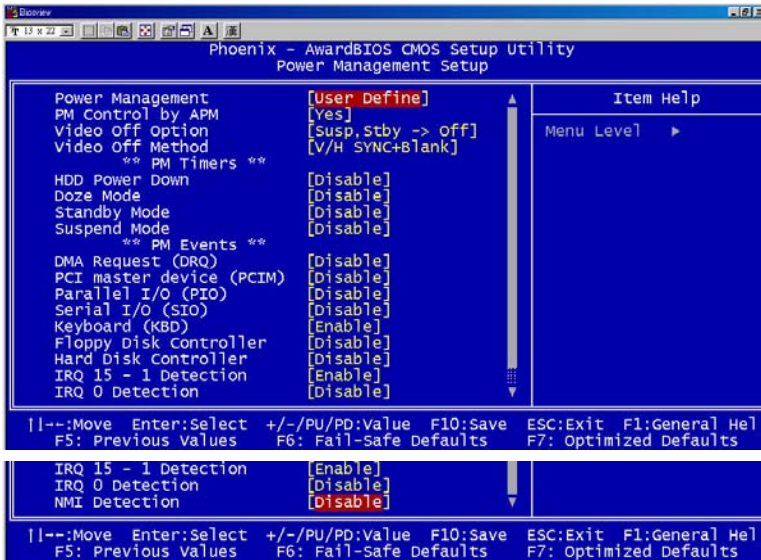

3.8 PnP/PCI configuration

By choosing the PnP/PCI configurations from the Initial Setup Screen menu, the screen below is displayed. This sample screen contains the manufacturer's default values for the HSB-440I.

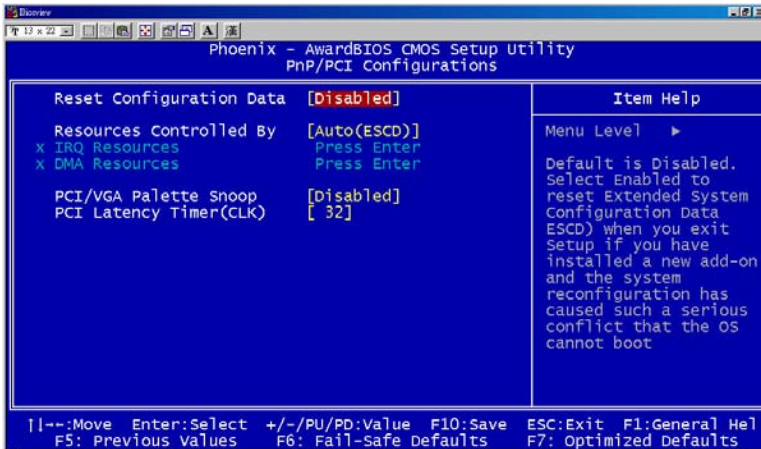

3.11 Load Fail-Safe Defaults

When you press <Enter> on this item you get a confirmation dialog box with a message similar to:

Load Fail-Safe Default (Y/N)?

Pressing "Y" loads the BIOS default values for the most stable, minimal performance system operations.

3.12 Load Optimized Defaults

When you press <Enter> on this item you get a confirmation dialog box with a message similar to:

Load Optimized Defaults (Y/N)?

Pressing "Y" loads the default values that are manufacturer's settings for optimal performance system operations.

3.13 Set Password

To abort the process at any time, press Esc.

In the Security Option item in the BIOS Features Setup screen, select System or Setup:

System Enter a password each time the system boots and whenever you enter Setup.

Setup Enter a password whenever you enter Setup.

NOTE: To clear the password, simply press Enter when asked to enter a password. Then the password function is disabled.

3.14 Save & Exit setup

If you select this option and press <Enter>, the values entered in the setup utilities will be saved in the chipset's CMOS memory. The microprocessor will check this every time you turn on your system and compare this to what it finds as it checks the system. This record is required for the system to operate.

3.15 Exit without saving

Selecting this option and pressing <Enter> allows you to exit the Setup program without save any new value or changing old one.

Appendix

A

**Programming the
Watchdog Timer**

A.1 Programming the watchdog timer

The HSB-4401 contains a watchdog timer reset pin (GP16). All reference material can be found below.

```
=====
** Title: WatchDog Timer Setup Utility (for W83977 GP16)
```

```
** Compiler: Borland C ++ Version 3.0
=====
```

```
#include <dos.h>
#include <io.h>
#include <bios.h>
#include <stdio.h>
#include <stdlib.h>
#include <conio.h>
/* Set I/O Address : 3F0/3F1 */
#define IO_INDEX_PORT 0x3f0
#define IO_DATA_PORT 0x3f1
/* Set Watchdog reset pin : 16 */
#define watch_dog_output_GP 16
#define UNLOCK_DATA 0x87
#define LOCK_DATA 0xAA
#define DEVICE_REGISTER 0x07
void EnterConfigMode()
{
    outportb(IO_INDEX_PORT, UNLOCK_DATA);
    outportb(IO_INDEX_PORT, UNLOCK_DATA);
}
void ExitConfigMode()
{
    outportb(IO_INDEX_PORT, LOCK_DATA);
}
void SelectDevice(unsigned char device)
{
    outportb(IO_INDEX_PORT, DEVICE_REGISTER);
    outportb(IO_DATA_PORT, device);
}
```

```

unsigned char ReadAData(short int reg)
{
    outportb(IO_INDEX_PORT, reg);
    return (inportb(IO_DATA_PORT));
}
void WriteAData(unsigned char reg, unsigned char data)
{
    outportb(IO_INDEX_PORT, reg);
    outportb(IO_DATA_PORT, data);
}
void SetWatchDogTime(unsigned char time_val)
{
    EnterConfigMode();
    SelectDevice(8);
    //Set Register F2
    //Set Watch -Dog Timer 1~ 256
    WriteAData(0xF2, time_val);
    //Set Register F3
    //keyboard and mouse interrupt reset Enable
    //When Watch -Dog Time-out occurs,Enable POWER LED
    output
    WriteAData(0xF3, 0x0E);
    // set counter counts in second (or minute)
    // Register F4 Bit 6 = 0/1 (minutes/seconds)
    // For w83977EF only
    WriteAData(0xF4, 0x42);
    // ExitConfigMode();
}
void init_w83977tf_aw_watchdog()
{
    short int value;
    //Enter W83977 Configure Mode
    // EnterConfigMode();
    //Set Device Active
    WriteAData(0x30, 0x01);
    //Select Device 7
    SelectDevice(7);
}

```

```
//caution:skip this step will be a mistake!!
if (watch_dog_output_GP==12)
{
//Set Register E2 to define GP12
WriteAData(0xE2, 0x0A);
}
else if(watch_dog_output_GP==13)
{
//Set Register E3 to define GP13
WriteAData(0xE3, 0x0A);
}
else if(watch_dog_output_GP==16)
{
//Set Register E6 to define GP16
WriteAData(0xE6, 0x0A);
}
//Set Device Active
WriteAData(0x30, 0x01);
//Select Device 8
// SelectDevice(8);
//caution:skip this step will be a mistake!!
if (watch_dog_output_GP==12)
{
//Set Register 2A (PIN 57) Bit 7 = 0/1
(KBLOCK/GP12)
//set to GP12 for WD Rst
WriteAData(0x2A,ReadAData(0x2A) | 0x80);
}
else if(watch_dog_output_GP==13)
{
//Set Register 2B (PIN 58) Bit 0 = 0/1
(KBLOCK/GP13)
//set to GP13 for WD Rst
WriteAData(0x2B,ReadAData(0x2B) | 0x01);
}
else if(watch_dog_output_GP==16)
{
```

```
//Set Register 2C (PIN 119) Bit 5-4 = 01 (GP16)
//set to GP16 for WD Rst
WriteAData(0x2C,ReadAData(0x2C)|0x10);
}
//Exit W83977 Configure mode
ExitConfigMode();
}
void main(int argc, char* argv[])
{
int time_value=0;
char *ptr;
printf("WinBond 83977 WatchDog Timer Setup Utility Version
1.0 \n");
printf("\n");
printf("This version only for W83977 that using GP%d to Reset
System.\n",watch_dog_output_GP);
if (argc == 1)
{
printf("\n Syntax: WATCHDOG [time] \n");
printf(" time range : 1 ~ 256 \n\n");
return ;
}
if (argc > 1)
{
ptr = argv[1];
time_value = atoi(ptr);
}
if (time_value > 0 && time_value < 256)
{
SetWatchDogTime((unsigned char) time_value);
init_w83977tf_aw_watchdog();
printf("Watch Dog Timer set up : %d \n",time_value);
}
}
}
```

Appendix

B

**CompactFlash® Cover
Installation Guide**

B.1 How to install the CompactFlash cover

HSB-440I is given a CompactFlash Card cover with the product. The purpose for the CompactFlash Card cover is to prevent users from dropping the CompactFlash Card under the condition of the delivery and system operation.

Please follow the steps below to install the CompactFlash Card cover. The instructions are simply for your reference which mean you may install the CompactFlash Card cover in the way you prefer.

Step 1: Plug in CompactFlash Card



Step 2: Push the CompactFlash Card forward until the end.

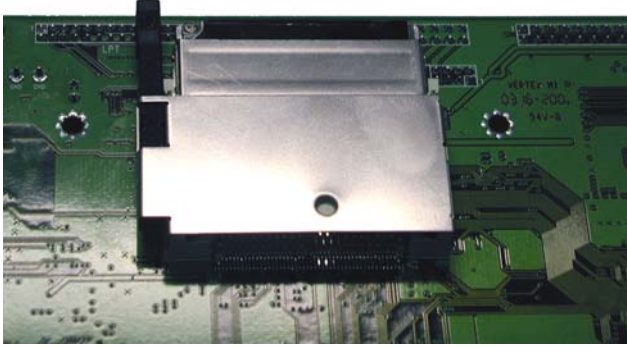

Step 3: Put the cover on from the right to left and hook up the CompactFlash Card white base with the crook on the cover.

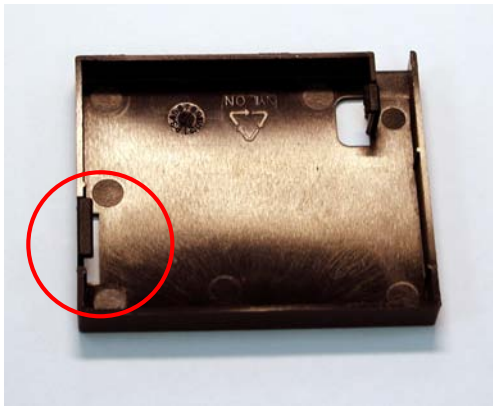

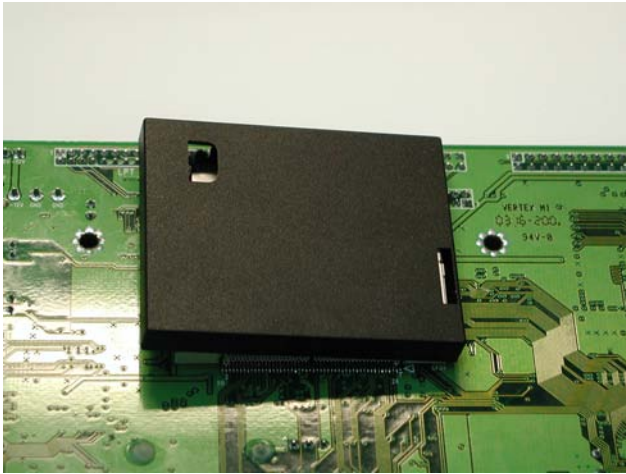

Step 4: Press a little bit with the finger on the hole of the cover.

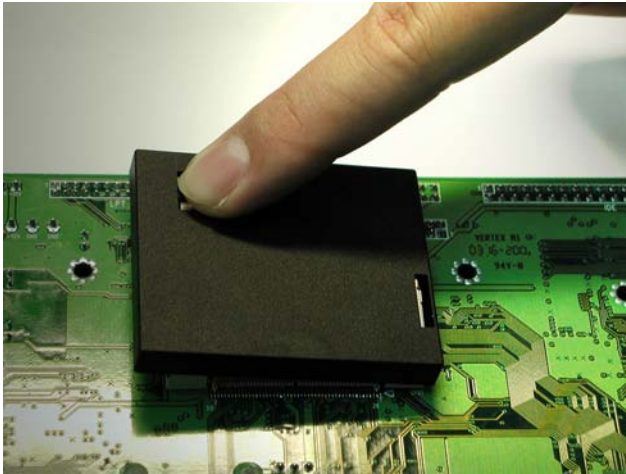

Step 5: Done

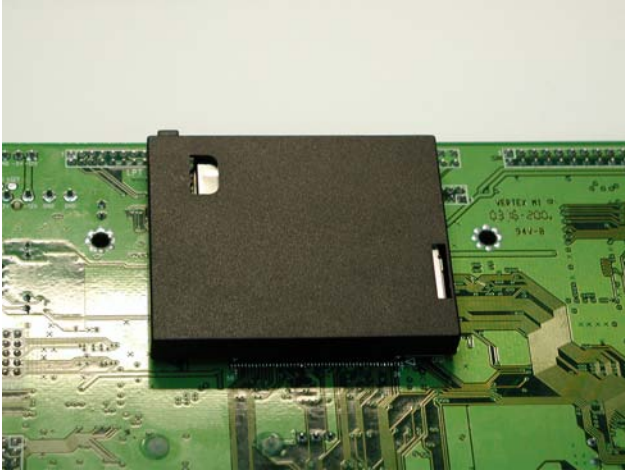

B.2 How to disassemble the CompactFlash cover

If you would like disassemble the CompactFlash Card, please follow the steps below. If you don't follow the regular steps to disassemble, the cover may suffer the permanent damage.

Step 1: Pull the cover a little bit from the corner indicated.



Step 2: Pull the cover hard from the reverse corner indicated.

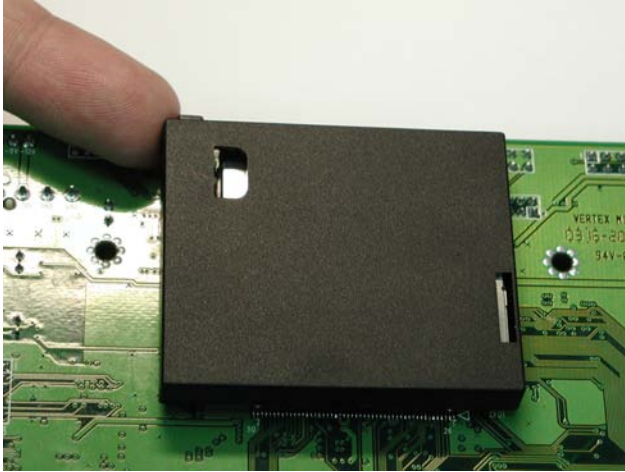

In this way, the cover can be disassembled as easy as possible.