

SBC-775

Pentium® II Full-size CPU
Card with SSD

Copyright Notice

This document is copyrighted, 1998, by AAEON Technology Inc. All rights are reserved. AAEON Technology Inc., reserves the right to make improvements to the products described in this manual at any time without notice.

No part of this manual may be reproduced, copied, translated or transmitted in any form or by any means without the prior written permission of AAEON Technology Inc. Information provided in this manual is intended to be accurate and reliable. However, AAEON Technology Inc. assumes no responsibility for its use, nor for any infringements upon the rights of third parties which may result from its use.

Acknowledgements

AWARD is a trademark of AWARD Software, Inc.

AMD is a trademark of Advanced Micro Devices, Inc.

IBM and PC are trademarks of International Business Machines Corporation.

Intel is a trademark of Intel Corporation.

MS-DOS is a trademark of Microsoft Corporation.

SMC is a trademark of Standard Microsystems Corporation.

NCR is a trademark of NCR Corporation.

All other product names or trademarks are the properties of their respective owners.

A Message to the Customer

AAEON Customer Services

Each and every AAEON product is built to the most exacting specifications to ensure reliable performance in the harsh and demanding conditions typical of industrial environments. Whether your new AAEON equipment is destined for the laboratory or the factory floor, you can be assured that your product will provide the reliability and ease of operation for which the name AAEON has come to be known.

Your satisfaction is our primary concern. Here is a guide to AAEON's customer services. To ensure you get the full benefit of our services, please follow the instructions below carefully.

Technical Support

We want you to get the maximum performance from your products. So if you run into technical difficulties, we are here to help. For the most frequently asked questions, you can easily find answers in your product documentation. These answers are normally a lot more detailed than the ones we can give over the phone.

So please consult this manual first. If you still cannot find the answer, gather all the information or questions that apply to your problem, and with the product close at hand, call your dealer. Our dealers are well trained and ready to give you the support you need to get the most from your AAEON products. In fact, most problems reported are minor and are able to be easily solved over the phone.

In addition, free technical support is available from AAEON engineers every business day. We are always ready to give advice on application requirements or specific information on the installation and operation of any of our products.

Product Warranty

AAEON warrants to you, the original purchaser, that each of its products will be free from defects in materials and workmanship for one year from the date of purchase.

This warranty does not apply to any products which have been repaired or altered by persons other than repair personnel authorized by AAEON, or which have been subject to misuse, abuse, accident or improper installation. AAEON assumes no liability under the terms of this warranty as a consequence of such events.

Because of AAEON's high quality-control standards and rigorous testing, most of our customers never need to use our repair service. If an AAEON product is defective, it will be repaired or replaced at no charge during the warranty period. For out-of-warranty repairs, you will be billed according to the cost of replacement materials, service time and freight. Please consult your dealer for more details.

If you think you have a defective product, follow these steps:

1. Collect all the information about the problem encountered. (For example, type of PC, CPU speed, AAEON products used, other hardware and software used, etc.) Note anything abnormal and list any on-screen messages you get when the problem occurs.
2. Call your dealer and describe the problem. Please have your manual, product, and any helpful information readily available.
3. If your product is diagnosed as defective, obtain an RMA (return material authorization) number from your dealer. This allows us to process your return more quickly.
4. Carefully pack the defective product, a fully-completed Repair and Replacement Order Card and a photocopy proof of purchase date (such as your sales receipt) in a shippable container. A product returned without proof of the purchase date is not eligible for warranty service.
5. Write the RMA number visibly on the outside of the package and ship it prepaid to your dealer.

Initial inspection

Before you begin installing your card, please make sure that the following materials have been shipped:

- 1 SBC-775 Pentium® II single board computer
- 1 Pentium II CPU and cooling fan (optional)
- 1 OBS temperature sensor
- 1 Quick Installation Guide
- 1 supporting CD-ROM
- 2 disks, for OBS Win95 drivers
- 1 FDD cable
- 1 EIDE HDD cables
- 1 printer cable
- 1 ivory cable for keyboard and mouse
- 1 ATX-to-PS/2 power cable
- 1 Pentium II CPU retention module

If any of these items are missing or damaged, contact your distributor or sales representative immediately.

We have carefully inspected the SBC-775 mechanically and electrically before shipment. It should be free of marks and scratches and in perfect working order upon receipt.

As you unpack the SBC-775, check it for signs of shipping damage. (For example, damaged box, scratches, dents, etc.) If it is damaged or it fails to meet the specifications, notify our service department or your local sales representative immediately. Also notify the carrier. Retain the shipping carton and packing material for inspection by the carrier. After inspection, we will make arrangements to repair or replace the unit.

Caution! *Always ground yourself to remove any static charge before touching the CPU card. Modern electronic devices are very sensitive to static electric charges. Try to use a grounding wrist strap at all times. Place all electronic components on a static-dissipative surface or in a static-shielded bag when they are not in the chassis.*

Contents

Chapter 1 Hardware Configuration	1
Introduction	2
Features	3
Specifications	4
System	4
Memory	4
Input/Output	4
Industrial features	5
Mechanical and environmental specifications	5
Board Layout: Main Features	6
Jumpers and Connectors	7
Board Layout: Jumper Locations.....	9
Board Layout: Connector Locations	10
Safety Precautions	11
Jumper Settings	12
How to set jumpers	12
CPU core frequency (J5)	12
CMOS clear (J6)	13
Watchdog timer output (J8)	13
CPU clock select (J11)	14
DiskOnChip® 2000 Flash disk address select (J12)	15
System Memory	16
Memory Installation Procedures.....	18
Cache Memory	19
Mounting the CPU and Cooling Modules	20
On-board Support Bracket	22

Chapter 2 Connecting Peripherals 23

Primary (CN6) and Secondary (CN7) IDE
Connectors 24
Floppy Drive Connector (CN13) 24
Parallel Port Connector (CN8) 25
Keyboard & PS/2 Mouse Connector (CN12) 25
Serial Ports (CN9: COM1; CN10: COM2) 26

Front Panel Connectors
(CN2, CN3, CN4, J1 and J2) 27
Keyboard lock and power on LED (CN2) 27
External speaker (CN3) 27
IDE LED (CN4) 27
ATX soft power switch (J1) 27
Reset (J2) 27

ATX Power Control Connectors (J7 and J1) 28
ATX feature connector (J7)
and soft power switch connector (J1) 28
Controlling the soft power switch 29

USB Connector (CN11) 29
IR Connector (CN1) 29
External Keyboard Connector (J10) 29
External Suspend Switch Lead (SMI) (J3) 30

Chapter 3 Award BIOS Setup	31
Introduction	32
Entering Setup	32
Standard CMOS Setup	32
BIOS Features Setup	33
Virus Warning	33
Quick Power On Self Test	34
Boot Sequence	34
Boot Up Floppy Seek	34
Boot Up NumLock Status	35
Boot Up System Speed	35
IDE HDD Block Mode	35
Gate A20 option	35
Typematic Rate setting	35
Typematic Rate (Char/Sec)	35
Typematic Delay (msec)	36
Security Option	36
OS select for DRAM>64 MB	36
Video BIOS Shadow	36
C8000 - CFFFF Shadow / DC000-DFFFF Shadow	36
CHIPSET Features Setup	37
Power Management Setup	38
Power Management	38
HDD Power Management	38
IRQ Activity	39
PCI Configuration Setup	39
Load BIOS Defaults	39
Load Setup Defaults	39
Integrated Peripherals	40
Password Setting	41
IDE HDD Auto Detection	41
Save & Exit Setup	42
Exit Without Saving	42

Chapter 4 On-board security setup	43
Introduction	44
Installation of OBS devices	45
Drive installation	45
Necessary prerequisites	45
Before you begin	45
Windows 95 drivers setup procedure	46
Appendix A Programming the Watchdog Timer	57
Programming the Watchdog Timer	58
Appendix B Pin Assignments	61
COM1/COM2 RS-232 Serial Port (CN9,CN10)	62
Keyboard and Mouse Connector (CN12)	62
External Keyboard Connector (J10)	62
ATX Feature Connector (J7).....	63
IDE Hard Drive Connector (CN6, CN7).....	63
USB Connector (CN11)	64
CPU Fan Power Connector (CN5)	64
Floppy Drive Connector (CN13)	65
Parallel Port Connector (CN8)	66
IR Connector (CN1)	67
HDD LED Connector (CN4).....	67
Power LED and Keylock Connector (CN2)	67
External Speaker (CN3)	68
System I/O Ports	69
DMA Channel Assignments	70
Interrupt Assignments	70
1st MB Memory Map	71
Appendix C DOC® 2000 Installation Guide	73
DiskOnChip 2000 Quick Installation Guide	74
DiskOnChip 2000 installation instructions	74
Additional information and assistance	75

Hardware Configuration

This chapter gives background information on the SBC-775, and shows you how to configure the card to match your application and prepare it for installation into your system.

Sections include:

- Card specifications
- Board layout
- Safety precautions
- Jumper settings

Introduction

The SBC-775 industrial grade CPU card uses Intel's highly acclaimed Pentium® II processor and Intel 440LX PCI chipset. The card works with standard ISA or PCI/ISA-bus passive backplanes.

The CPU provides 512 KB on-chip L2 cache, eliminating the need for external SRAM chips. It has two PCI EIDE interfaces (for up to four devices), and an FDD interface (for up to two devices). Other features include two RS-232 serial ports (16C550 UARTs with 16-byte FIFO or compatible), one enhanced parallel port (supports EPP/ECP), and support two USB (Universal Serial Bus) ports. The PCI BUS Master IDE controller supports Ultra DMA/33 operation. This provides data transfer rates of over 33 MB/sec, and allows drive capacities up to 8.4 GB. System BIOS supports boot-up from an IDE CD-ROM.

A backup of CMOS data is stored in the Flash memory, which protects data even after a battery failure. Also included is a 63-level watchdog timer, which resets the CPU or generates an interrupt if a program cannot be executed normally. This enables reliable operation in unattended environments.

Features

- Intel slot 1 architecture
- Pentium® II processor up to 333 MHz
- Intel 82440LX PCIset
- Three DIMM sockets for SDRAM up to 384 MB; supports ECC
- Award Flash BIOS
- On-board ATX power control connector to meet ACPI requirements
- Two enhanced IDE ports, supporting Ultra DMA/33, PIO Mode 4 and DMA Mode 2
- Two USB ports
- Two serial ports
- One bidirectional parallel port, supports ECP/EPP/SPP
- One floppy port and one keyboard/mouse port
- PCI V2.1 compliant
- PICMG 2.0 compliant
- Additional metal bracket to provide board stability with Pentium II processor
- CMOS backup battery life of 7 years
- Supports M-Systems DiskOnChip® 2000 Flash disk
- On-board security system for monitoring CPU fan and voltage

Specifications

System

- **CPU:** Intel Pentium® II up to 333 MHz
- **BIOS:** Award Flash BIOS
- **Green function:** Supports power management operation via BIOS. Activated by keyboard or mouse activity
- **PCI enhanced IDE hard disk drive interface:** Supports up to four IDE (AT bus) large hard disk drives (up to 8.4 GB), or other enhanced IDE devices. Supports PIO Mode 4 (16.67 MB/s data transfer rate) and Ultra DMA/33 (33 MB/s data transfer rate). BIOS enabled/disabled
- **Floppy disk drive interface:** Supports up to two floppy disk drives, 5¼" (360 KB and 1.2 MB) and/or 3½" (720 KB, 1.44 MB, and 2.88 MB). BIOS enabled/disabled

Memory

- **RAM:** Up to 384 MB in three available 168-pin DIMM sockets. Supports SDRAM
- **Error correction (parity DRAM only):** Modules can detect multi-bit memory errors. Correction of 1-bit memory errors

Input/Output

- **Bus interface:** PCI/ISA bus, PICMG compliant
- **Data bus:** 64-bit
- **Bus speed:**
 - ISA: 8 MHz
 - PCI: 33 MHz
- **DMA channels:** 7
- **Interrupt levels:** 15

- **Enhanced parallel port:** Configurable to LPT1, LPT2, LPT3, or disabled. Standard DB-25 female connector provided. Supports EPP/ECP/SPP
- **Serial ports:** Two RS-232 ports with 16C550 UARTs (or compatible) with 16-byte FIFO buffer. Supports speeds up to 115.2 Kbps. Ports can be individually configured to COM1, COM2, or disabled
- **Keyboard and PS/2 mouse connector:** A 6-pin mini DIN connector is located on the mounting bracket for easy connection to a keyboard or PS/2 mouse. An on-board keyboard pin header connector is also available

Industrial features

- **Watchdog timer:** Can generate a system reset or IRQ11. The watchdog timer is programmable, with each unit equal to one second (63 levels). The program uses I/O ports hex 043h and 443h to control the watchdog timer

Mechanical and environmental specifications

- **Operating temperature:** 0 ~ 60° C (32 ~ 140° F)
- **Power supply voltage:** +5 V, ±12 V
- **Power consumption:** +5 V @ 6.0 A (for Pentium® II 233 MHz)
+5 V @ 7.5 A (for Pentium® II 300 MHz)
+5 V @ 4.5 A (for Pentium® II 333 MHz)
- **Board size:** 338 x 122 mm (13.3" x 4.8")
- **Board weight:** 0.5 kg (1.2 lb)

Board Layout: Main Features

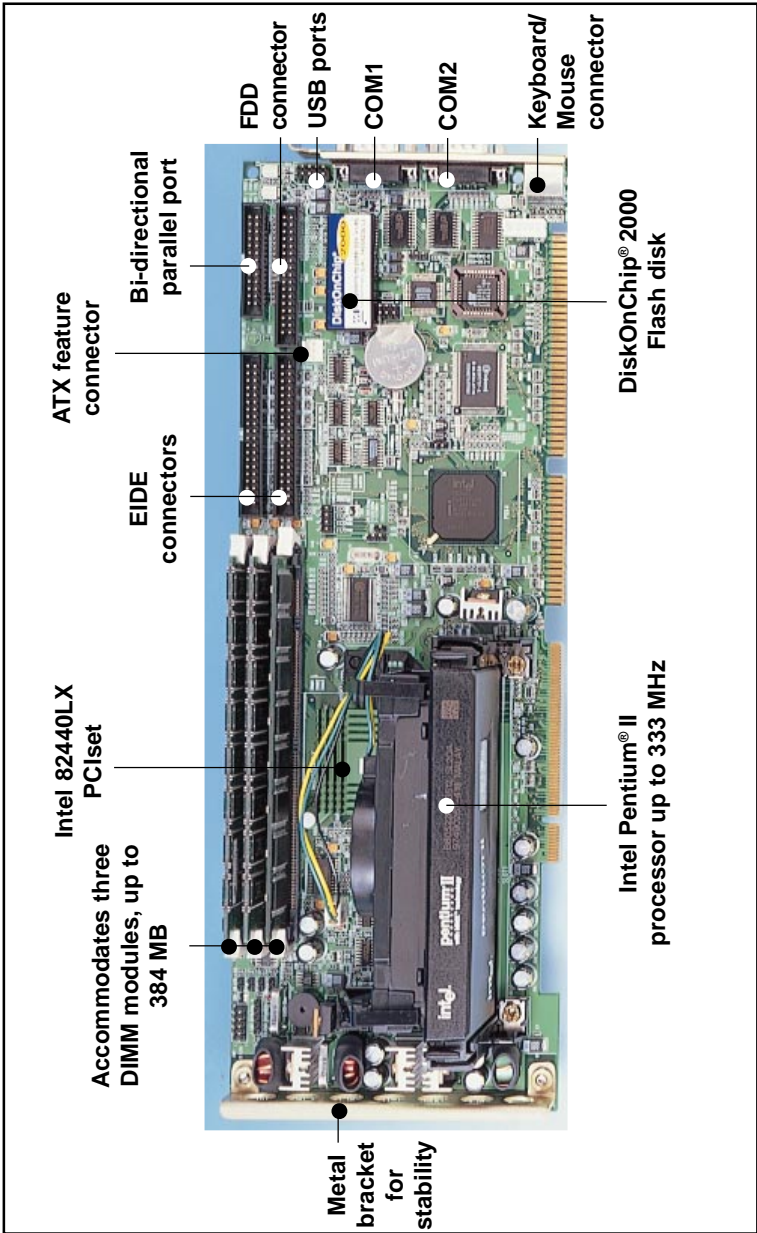

Jumpers and Connectors

Connectors on the SBC-775 board link it to external devices such as hard disk drives and a keyboard. In addition, the board has a number of jumpers used to configure your system for your application.

The tables below list the function of each of the board jumpers and connectors. Later sections in this chapter give instructions on setting jumpers. Chapter 2 gives instructions for connecting external devices to your card.

Table 1-1: Jumpers

Label	Function
J5	CPU core frequency
J6	Clear CMOS
J8	Watchdog output
J11	Clock select
J12	DiskOnChip® 2000 address select

Table 1-2: Connectors

Number Function

CN1	Infrared (IR) connector
CN2	Keyboard lock
CN3	External speaker
CN4	IDE LED
CN5	CPU fan connector
CN6	Primary IDE connector
CN7	Secondary IDE connector
CN8	Parallel port
CN9	Serial port: COM 1
CN10	Serial port: COM 2
CN11	USB port
CN12	PS/2 keyboard and mouse
CN13	Floppy drive connector
CN14	(Reserved)
J1	ATX soft power switch
J2	Reset
J3	External SMI
J7	ATX feature connector
J10	External keyboard connector
RT1	(Reserved)

Board Layout: Jumper Locations

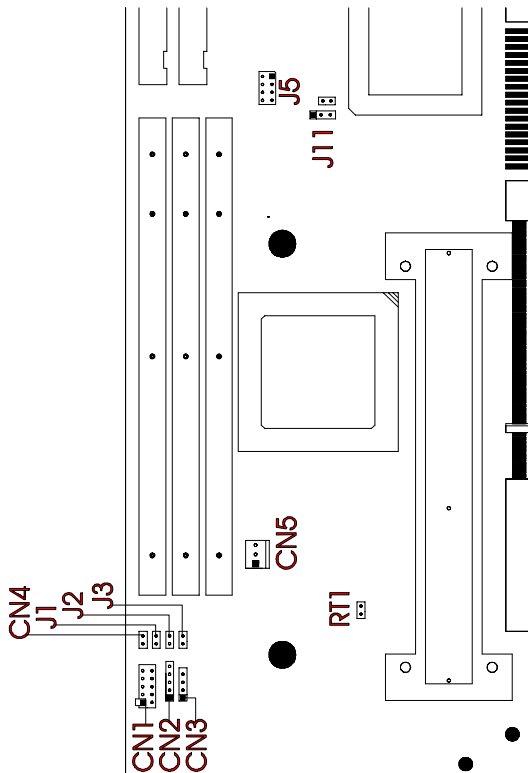
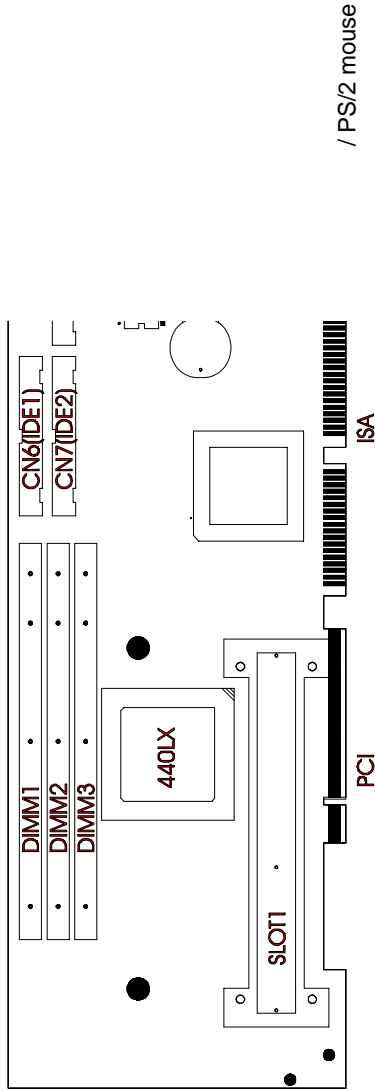

Figure 1-1: Board layout: jumper locations

Board Layout: Connector Locations



/ PS/2 mouse

Figure 1-2: Board layout: connector locations

Safety Precautions

Warning!



Always completely disconnect the power cord from your chassis whenever you work with the hardware. Do not make connections while the power is on. Sensitive electronic components can be damaged by sudden power surges. Only experienced electronics personnel should open the PC chassis.

Caution!



Always ground yourself to remove any static charge before touching the CPU card. Modern electronic devices are very sensitive to static electric charges. As a safety precaution, use a grounding wrist strap at all times. Place all electronic components in a static-dissipative surface or static-shielded bag when they are not in the chassis.

Jumper Settings

This section provides instructions on how to configure your card by setting jumpers. It also includes the card's default settings and your options for each jumper.

How to set jumpers





You configure your card to match the needs of your application by setting jumpers. A jumper is the simplest kind of electric switch. It consists of two metal pins and a small metal clip (often protected by a plastic cover) that slides over the pins to connect them. To “close” a jumper you connect the pins with the clip. To “open” a jumper you remove the clip. Sometimes a jumper consists of a set of three pins, labeled 1, 2 and 3. In this case you connect either pins 1 and 2, or 2 and 3.

A pair of needle-nose pliers may be useful when setting jumpers.

CPU core frequency (J5)

You must configure your SBC-775 CPU card to the frequency of your Intel Pentium® II processor by setting jumper J5. The SBC-775 is equipped to use Pentium processors with speeds of 233, 266, 300 and 333 MHz. Configure your SBC-775 as follows:

Table 1-3: CPU core frequency (J5)



	A	B	C	D	
233 MHz	open	closed	closed	closed	
266 MHz	open	open	open	open	
300 MHz*	open	closed	open	open	
333 MHz	open	open	closed	open	

* default

CMOS clear (J6)

The SBC-775 CPU card contains a jumper that can erase CMOS data and reset the system BIOS information. Normally this jumper should be set with pins 1-2 closed. If you want to reset the CMOS data, set J6 to 2-3 closed for just a few seconds, and then move the jumper back to 1-2 closed. This procedure will reset the CMOS to its default setting.

Table 1-4: CMOS clear jumper settings (J6)



Function	Jumper setting	
Keep CMOS data	1-2 closed*	
Clear CMOS data	2-3 closed	

* default

Watchdog timer output (J8)

The SBC-775 contains a watchdog timer that will reset the CPU or send a signal to IRQ11 in the event the CPU stops processing. This feature means the SBC-775 will recover from a software failure or an EMI problem. The J8 jumper settings control the outcome of what the computer will do in the event the watchdog timer is tripped.

Table 1-5: Watchdog timer output (J8)



Function	Jumper setting	
IRQ11	1-2 closed	
Reset	2-3 closed*	

* default

CPU bus clock select (J11)

The CPU clock varies according to the Pentium® II processor's CPU bus clock. There are two settings for the CPU clock, 66.6 MHz and 75 MHz.

Table 1-6: CPU clock select jumper settings (J11)

Function	Jumper setting	
66.6 MHz	1-2 closed*	
75 MHz	2-3 closed	

* default









Note: 75 MHz exceeds the product's specifications.

DiskOnChip® 2000 Flash disk address select (J12)

The SBC-775 includes a 32-pin socket for M-System's DiskOnChip 2000 Flash disk module. This revolutionary solid state disk enables critical system information to be stored within an on-board Flash disk for virtually instantaneous data access.

You must specify the memory address you wish to use for your DiskOnChip 2000 Flash disk module by setting jumper (J12). Available settings are as follows:

Table 1-7: DiskOnChip® 2000 Flash disk memory address jumper settings (J12)

Address	1-2	3-4	5-6	
C800	closed	closed	closed	
CC00	closed	closed	open	
D000	closed	open	closed	
D400	closed	open	open	
D800	open	closed	closed	
DC00	open	closed	open	
E000	open	open	closed	
Disabled*	open	open	open	

* default

System Memory

The top-left edge of the SBC-775 contains three sockets for 168-pin dual inline memory modules (DIMMs). All three sockets use 3.3 V unbuffered synchronous DRAMs (SDRAM). DIMMs are available in capacities of 16, 32, 64 or 128 MB. The sockets can be filled in any combination with DIMMs of any size, giving your SBC-775 single board computer between 16 and 384 MB of memory. Use the following table to calculate the total DRAM memory within your computer:

Table 1-8: DIMM module allocation table

Socket number	168-pin DIMM memory
1	(8, 16, 32, 64 or 128 MB) x 1
2	(8, 16, 32, 64 or 128 MB) x 1
3	(8, 16, 32, 64 or 128 MB) x 1

Sample calculation: DIMM memory capacity

Suppose you install a 128 MB DIMM into your SBC-775's socket 1, a 32 MB DIMM into socket 2, and you leave socket 3 empty. Your total system memory is calculated as follows, and is 160 MB:

Table 1-9: DIMM memory capacity sample calculation

Socket number	168-pin DIMM memory		Total memory
1	128 MB	x 1	128 MB
2	32 MB	x 1	32 MB
3	-	x 1	0 MB
Total memory			160 MB

Supplementary information about DIMMs

Your SBC-775 can accept four kinds of memory chips: EDO (with or without parity), and SDRAM (with or without parity). Also:

- SDRAM chips are usually thinner and have higher pin density than EDO chips.
- The BIOS displays EDO and SDRAM memory on the boot-up screen.
- Chips with 9 chips/side support parity; chips with 8 chips/side do not support parity.
- Single-sided modules are typically 16 or 64 MB; double-sided modules are usually 8, 32 or 128 MB.

Note: *The SBC-775 accepts EDOs both with and without parity, but this is not recommended.*

Memory Installation Procedures

To install DIMMs, first make sure the two handles of the DIMM socket are in the "open" position. i.e. The handles remain outward. Slowly slide the DIMM module along the plastic guides on both ends of the socket. Then press the DIMM module right down into the socket, until you hear a click. This is when the two handles have automatically locked the memory module into the correct position of the DIMM socket. (See Figure 1-3.) To take away the memory module, just push both handles outward, and the memory module will be ejected by the mechanism in the socket.

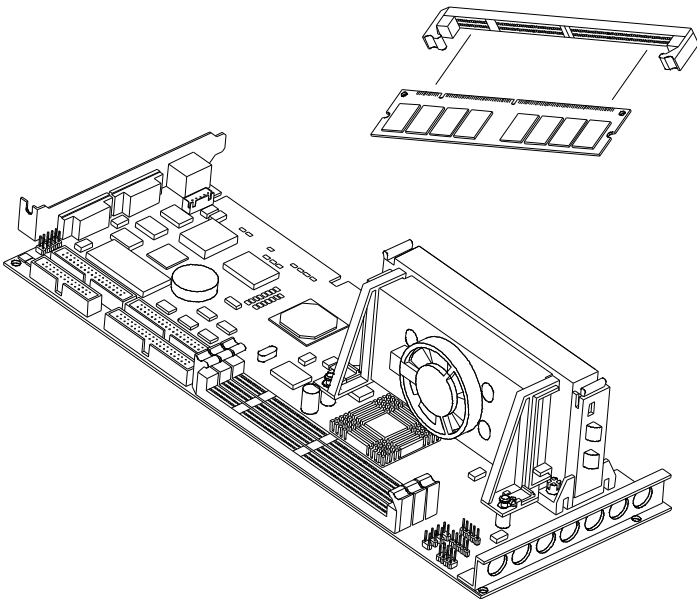

Figure 1-3: DIMM installation

Cache Memory

Since the second level cache has been embedded into the Pentium® II CPU, you do not have to take care of either SRAM chips or SRAM modules. The built-in second level cache in the Pentium II yields much higher performance than the external cache memories. The cache size in the Pentium II CPU is either 256 KB or 512 KB. Normally, for workstation and server application, the 256 KB version is enough. However, if your system is for heavy duty applications, the 512 KB version will help a lot. Specifically for our Pentium II based SBC, the Pentium II has another version that provides much better data security if combined with the DRAM ECC. Check with your vendor for various Pentium II models.

Mounting the CPU and Cooling Modules

The Pentium® II is a module-type CPU which runs at high speeds, for example 233 ~ 333 MHz, so the cooling mechanism becomes critical for system reliability. There are two types of cooling methods: one with a cooling fan attached to the heat sink of the Pentium II module, the other with a huge heat sink without any cooling fan attached.

Both cooling methods for the Pentium II require a "retention module" to firmly fix the Pentium II CPU to slot 1. The following Figures 1-4 through 1-6 illustrate the steps involved in mounting the retention module and installing the CPU and cooling modules.

Step 1

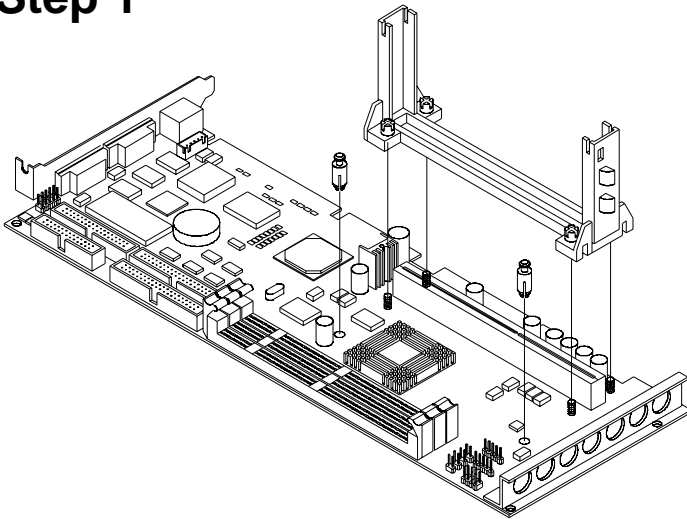
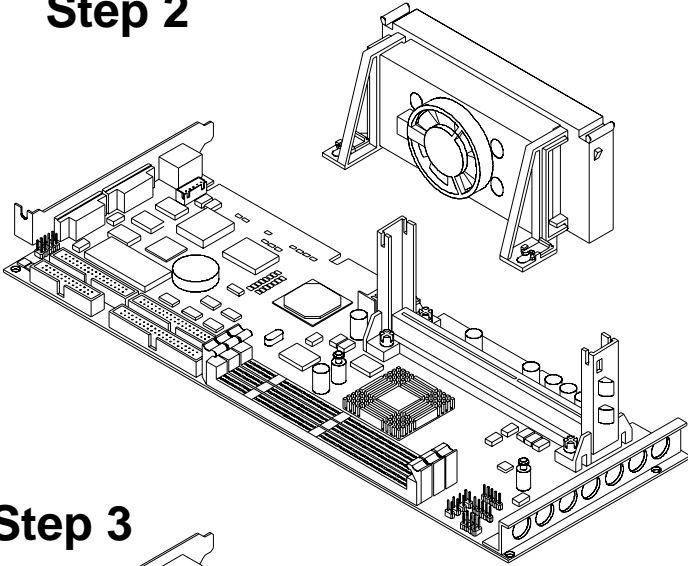

Figure 1-4: Mounting CPU and cooling modules - Step 1

Figure 1-5: Mounting CPU and cooling modules - Step 2

Step 2



Step 3

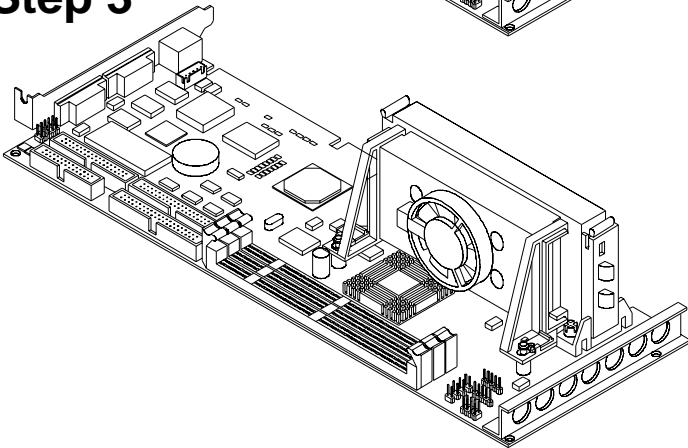

Figure 1-6: Mounting CPU and cooling modules - Step 3

On-board Support Bracket

The SBC-775 also includes an on-board metal bracket to provide balanced support for the Pentium II processor cartridge.

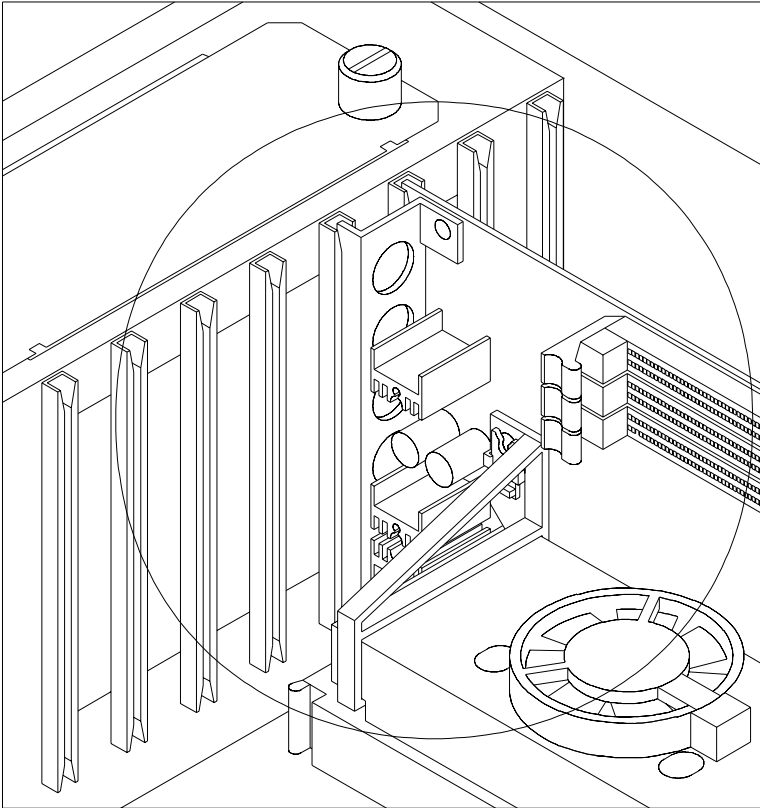

Figure 1-7: On-board support bracket

CHAPTER 2

Connecting Peripherals

This chapter tells how to connect peripherals, switches and indicators to the SB-775 board. You can access most of the connectors from the top of the board while it is installed in the chassis. If you have a number of cards installed, or your chassis is very tight, you may need to partially remove the card to make all the connections.

Primary (CN6) and Secondary (CN7) IDE Connectors

You can attach up to four IDE (Integrated Device Electronics) drives to the SBC-775's internal controller. The primary (CN6) and secondary (CN7) connectors can each accommodate two drives.

Wire number 1 on the cable is red or blue and the other wires are gray. Connect one end to connector CN6 or CN7 on the CPU card. Make sure that the red/blue wire corresponds to pin 1 on the connector (in the upper right hand corner). See Chapter 1 for help finding the connector.

Unlike floppy drives, IDE hard drives can connect in either position on the cable. If you install two drives to a single connector, you will need to set one as the master and one as the slave. You do this by setting the jumpers on the drives. If you use just one drive per connector, you should set each drive as the master. See the documentation that came with your drive for more information.

Connect the first hard drive to the other end of the cable. Wire 1 on the cable should also connect to pin 1 on the hard drive connector, which is labeled on the drive circuit board. Check the documentation that came with the drive for more information.

Connect the second hard drive to the remaining connector (CN7 or CN6), in the same way as described above.

Floppy Drive Connector (CN13)

You can attach up to two floppy disk drives to the SBC-775's on-board controller. You can use any combination of 5.25" (360 KB/1.2 MB) and/or 3.5" (720 KB/1.44/2.88 MB) drives.

The card comes with a 34-pin daisy-chain drive connector cable. On one end of the cable is a 34-pin flat-cable connector. On the other end are two sets of floppy disk drive connectors. Each set consists of a 34-pin flat-cable connector (usually used for 3.5" drives) and a printed circuit-board connector (usually used for 5.25" drives). You can use only one connector in each set. The set on the end (after the twist in the cable) connects to the A: floppy drive. The set in the middle connects to the B: floppy drive.

Parallel Port Connector (CN8)

The parallel port is normally used to connect the CPU card to a printer. The SBC-775 includes an on-board parallel port, accessed through a 26-pin flat-cable connector, CN8. The card comes with an adapter cable which lets you use a traditional DB-25 connector. The cable has a 26-pin connector on one end and a DB-25 connector on the other, mounted on a retaining bracket. The bracket installs at the end of an empty slot in your chassis, giving you access to the connector.

The parallel port is designated as LPT1 and can be disabled or changed to LPT2 or LPT3 in the system BIOS setup.

To install the bracket, find an empty slot in your chassis. Unscrew the plate that covers the end of the slot. Screw in the bracket in place of the plate. Next, attach the flat-cable connector to CN8 on the CPU card. Wire 1 of the cable is red or blue, and the other wires are gray. Make sure that wire 1 corresponds to pin 1 of CN8. Pin 1 is on the upper right side of CN8.

Keyboard & PS/2 Mouse Connector (CN12)

The SBC-775 board provides a keyboard connector. A 6-pin mini-DIN connector (CN12) on the card mounting bracket supports single-board computer applications. The card comes with an adapter to convert from the 6-pin mini-DIN connector to a standard keyboard DIN connector and to a PS/2 mouse connector.

Serial Ports (CN9: COM1; CN10: COM2)

The SBC-775 offers two serial ports, CN9 as COM1 and CN10 as COM2. These ports can connect to serial devices (such as a mouse, printers, and so on) or to a communication network.

Table 2-1: Serial port connections (COM1, COM2)

Connector	Ports	Address	Interrupt
CN9	COM1	3F8*, 3E8	IRQ4
CN10	COM2	2F8*, 2E8	IRQ3

* default settings

The IRQ and address ranges for both ports are fixed. However, if you want to disable the port or change these parameters later, you can do this in the system BIOS setup.

Different devices implement the RS-232 standard in different ways. If you are having problems with a serial device, be sure to check the pin assignments for the connector.

Front Panel Connectors

(CN2, CN3, CN4, J1 and J2)

There are several external switches to monitor and control the SBC-775.

Keyboard lock and power on LED (CN2)

CN2 is a 5-pin connector for the keyboard lock and power on LED connection. Refer to Appendix B.12 for detailed information on the pin assignments. If a PS/2 power supply is used, the system's power LED status will be one of the following:

<u>PS/2 Power Mode</u>	<u>LED Status</u>
System On	On
System Suspend	Flashes eight times/sec.
System Off	Off

If an ATX power supply is used, refer to Section 2.7.2.

External speaker (CN3)

CN3 is a 4-pin connector for an external speaker connection. If there is no external speaker, the SBC-775 provides an on-board buzzer as an alternative. To enable the buzzer, set pins 3-4 as closed.

IDE LED (CN4)

You can connect an LED to connector CN4 to indicate when the HDD is active.

ATX soft power switch (J1)

If your computer case is equipped with an ATX power supply, you should connect the power on/off button on your computer case to J1. This connection enables you to turn your computer on and off.

Reset (J2)

Many computer cases offer the convenience of a reset button. Connect the wire from the reset button to J2.

ATX Power Control Connectors (J7 and J1)

ATX feature connector (J7) and soft power switch connector (J1)

The SBC-775 can support an advanced soft power switch function if an ATX power supply is used. To enable the soft power switch function:

1. Take the specially designed ATX-to-PS/2 power cable out of the SBC-775's accessory bag.
2. Connect the 3-pin plug of the cable to J7 (ATX feature connector).
3. Connect the power on/off button to J1. (A momentary type of button should be used.)

Warnings: 1. Make sure that you unplug your power supply when adding or removing expansion cards or other system components. Failure to do so may cause severe damage to both your CPU card and expansion cards.



2. ATX power supplies may power on if certain motherboard components or connections are touched by metallic objects.

Important: Be sure that the ATX power supply can take at least a 10 mA load on the 5 V standby lead (5VSB). If not, you may have difficulty powering on your system.

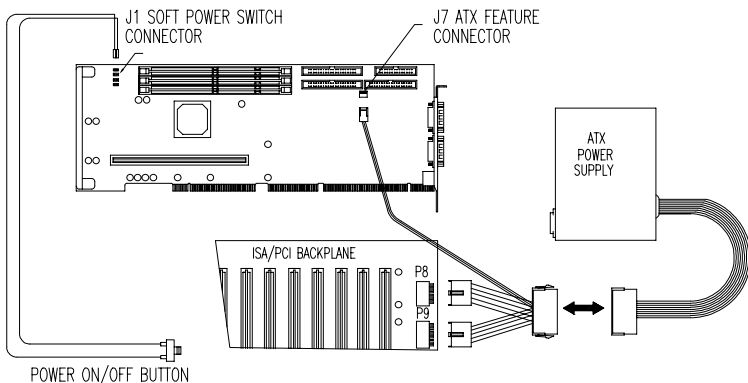

Controlling the soft power switch

It is easy to control the ATX soft power switch. Pushing the button once will switch the system between the "On" and "Suspend" power modes. Pushing the button for more than 4 seconds while in the "On" mode will turn the system off. Users can also identify the current power mode through the system's power LED, as indicated below:

ATX Power Mode LED Status

System On	On
System Suspend	Flashes eight times/sec.
System Off	Flashes once/sec.

USB Connector (CN11)

The SBC-775 CPU card provides two USB (Universal Serial Bus) interfaces, which give complete plug and play, hot attach/detach for up to 127 external devices. The USB interfaces comply with USB Specification Rev. 1.0, and are fuse-protected.

The USB interfaces are accessed through a 10-pin flat-cable connector, CN11. The adapter cable has a 10-pin connector on one end and a USB connector on the bracket.

The USB interfaces can be disabled in the system BIOS setup.

IR Connector (CN1)

This connector supports the optional wireless infrared transmitting and receiving module. This module mounts on the system case. You must configure the setting through the BIOS setup.

External Keyboard Connector (J10)

In addition to the PS/2 mouse/keyboard connector on the SBC-775's rear plate, there is also an extra on-board external keyboard connector. This gives system integrators greater flexibility in designing their systems.

External Suspend Switch Lead (SMI) (J3)

This allows the user to manually place the system into a suspend mode or "Green" mode when the system is not in use. System activity is decreased to save electricity and prolong the life of certain components. The 2-pin connector connects to the case-mounted suspend switch. If you do not have a switch for the connector, you may use the "turbo switch", because it does not have any other function. SMI is activated when it detects a "short to open" moment. Therefore, leaving it shorted will not cause any problems. It may require one or two pushes depending on the position of the switch. Wake-up can be controlled by settings in the BIOS, but the keyboard will always allow wake-up. (The SMI lead cannot wake up the system.) If you want to use the SMI connector, the "Suspend" switch in the Power Management Setup of the BIOS software should be on the default setting "Enable".

CHAPTER

3

Award BIOS Setup

This chapter describes how to set the card's BIOS configuration data.

Introduction

Award's BIOS ROM has a built-in setup program that allows users to modify the basic system configuration. This type of information is stored in battery-backed RAM so that it retains the setup information when the power is turned off.

Entering Setup

Turn on the computer and press immediately, to allow you to enter the setup.

Standard CMOS Setup

Choose the "STANDARD CMOS SETUP" option from the "INITIAL SETUP SCREEN" menu, and the screen below will be displayed. This standard setup menu allows users to configure system components such as date, time, hard disk drive, floppy drive, display, and memory.

ROM PCI/ISA BIOS (2A69JAK9)
STANDARD CMOS SETUP
AWARD SOFTWARE, INC.

Date (mm:dd:yy) : Mon, Feb 9 1998							
Time (hh:mm:ss) : 19 : 42 : 3							
HARD DISKS	TYPE	SIZE	CYLS	HEAD	PRECOMP	LANDZ	SECTOR MODE
Primary Master	: Auto	0	0	0	0	0	0 NORMAL
Primary Slave	: None	0	0	0	0	0	0 -----
Secondary Master	: Auto	0	0	0	0	0	0 NORMAL
Secondary Slave	: None	0	0	0	0	0	0 -----
Drive A	: 1.44M, 3.5 in.						
Drive B	: None						
Video	: EGA/UGA						
Halt On	: All, But Keyboard						
				Base Memory:		0K	
				Extended Memory:		0K	
				Other Memory:		512K	
				Total Memory:		512K	
ESC	: Quit	↑ ↓ → ←	: Select Item		PU/PD/+/- : Modify		
F1	: Help	(Shift)F2	: Change Color				

Figure 3-1: CMOS setup screen

BIOS Features Setup

The "BIOS FEATURES SETUP" screen appears when choosing the "BIOS FEATURES SETUP" item from the "CMOS SETUP UTILITY" menu. It allows users to configure the SBC-775 according to their particular requirements.

Below are some major items that are provided in the BIOS FEATURES SETUP screen:

```
ROM PCI/ISA BIOS (2A69JAK9)
BIOS FEATURES SETUP
AWARD SOFTWARE, INC.
```

Virus Warning	: Disabled	Video BIOS Shadow	: Enabled
CPU Internal Cache	: Enabled	C8000-CBFFF Shadow	: Disabled
External Cache	: Enabled	CC000-CFFFF Shadow	: Disabled
Quick Power On Self Test	: Enabled	D0000-D3FFF Shadow	: Disabled
Boot Sequence	: C,A,SCSI	D4000-D7FFF Shadow	: Disabled
Swap Floppy Drive	: Disabled	D8000-DBFFF Shadow	: Disabled
Boot Up Floppy Seek	: Enabled	DC000-DFFFF Shadow	: Disabled
Boot Up NumLock Status	: On		
Boot Up System Speed	: High		
Gate A20 Option	: Fast		
Typematic Rate Setting	: Disabled		
Typematic Rate (Chars/Sec)	: 6		
Typematic Delay (Msec)	: 250		
Security Option	: Setup		
PCI/VGA Palette Snoop	: Disabled		
OS Select For DRAM > 64MB	: Non-OS2		
		ESC : Quit	↑↓←→ : Select
		F1 : Help	PU/PD/+/- : Mo
		F5 : Old Values (Shift)	F2 : Co
		F6 : Load BIOS Defaults	
		F7 : Load Setup Defaults	

Figure 3-2: BIOS features setup screen

Virus Warning

During and after the system boots up, any attempt to write to the boot sector or partition table of the hard disk drive will halt the system. In this case, a warning message will be displayed. You can run the anti-virus program to locate the problem.

If Virus Warning is disabled, no warning message will appear if anything attempts to access the boot sector or hard disk partition.

Quick Power On Self Test

This option speeds up the Power-On Self Test (POST) conducted as soon as the computer is turned on. When enabled, BIOS shortens or skips some of the items during the test. When disabled, the computer conducts normal POST procedures.

Boot Sequence

This function determines the sequence in which the computer will search the drives for the disk operating system (i.e. DOS). The BIOS provides the following boot sequences:

- A,C, SCSI
- C,A. SCSI (Default)
- C, CDROM, A
- CDROM, C, A
- D, A, SCSI
- E, A, SCSI
- F, A, SCSI
- SCSI, A, C
- SCSI, C, A
- C only
- LS120, C

Boot Up Floppy Seek

During POST, BIOS will determine if the floppy disk drive installed is 40 or 80 tracks. A 360 KB type drive is 40 tracks; while 720 KB, 1.2 MB, and 1.44 MB type drives are all 80 tracks.

- Enabled BIOS searches the floppy drive to determine if it is 40 or 80 tracks. Note that BIOS cannot differentiate 720 KB, 1.2 MB, and 1.44 MB type drives as they are all 80 tracks.
- Disabled BIOS will not search for the floppy drive type by track number. Note that there will not be any warning message if the drive installed is 360 KB.

Boot Up NumLock Status

The default is “On”.

- On Keypad boots up to number keys.
- Off Keypad boots up to arrow keys.

Boot Up System Speed

- High Sets the speed to high.
- Low Sets the speed to low.

IDE HDD Block Mode

- Enabled Enable IDE HDD Block Mode.
 BIOS will detect the block size of the HDD and send a
 block command automatically.
- Disabled Disable IDE HDD Block Mode.

Gate A20 Option

- Normal The A20 signal is controlled by the keyboard
 controller or chipset hardware.
- Fast (Default) The A20 signal is controlled by Port 92 or the
 chipset specific method.

Typematic Rate Setting

The typematic rate determines the characters per second accepted by the computer. The Typematic Rate setting enables or disables the typematic rate.

Typematic Rate (Chars/Sec)

BIOS accepts the following input values (characters/second) for typematic rate: 6, 8, 10, 12, 15, 20, 24, 30.

Typematic Delay (msec)

Typematic delay is the time interval between the appearance of the first and second characters, when holding down a key. The input values for this category are: 250, 500, 750, 1000 (msec).

Security Option

This setting determines whether the system will boot up if the password is denied. Access to Setup is, however, always limited.

- | | |
|--------|--|
| System | The system will not boot, and access to Setup will be denied if the correct password is not entered at the prompt. |
| Setup | The system will boot, but access to Setup will be denied if the correct password is not entered at the prompt. |

Note: To disable security, select "PASSWORD SETTING" in the main menu. At this point, you will be asked to enter a password. Simply press <Enter> to disable security. When security is disabled, the system will boot, and you can enter Setup freely.

OS Select for DRAM > 64 MB

This setting is under the OS/2 system.

Video BIOS Shadow

This determines whether video BIOS will be copied to RAM, which is optional according to the chipset design. When enabled, Video BIOS Shadow increases the video speed.

C8000-CBFFF Shadow / DC000-DFFFF Shadow

These determine whether optional ROM will be copied to RAM in blocks of 16 KB.

- | | |
|----------|------------------------------|
| Enabled | Optional shadow is enabled. |
| Disabled | Optional shadow is disabled. |

CHIPSET Features Setup

By choosing the “CHIPSET FEATURES SETUP” option from the INITIAL SETUP SCREEN menu, the screen below will be displayed. This sample screen contains the manufacturer’s default values for the SBC-775.

ROM PCI/ISA BIOS (2A69JAK9)
CHIPSET FEATURES SETUP
AWARD SOFTWARE, INC.

Auto Configuration	: Enabled	Power-Supply Type	: Auto
DRAM Speed Selection	: 60ns		
MA Wait State	: Slow		
EDO RAS# To CAS# Delay	: 2		
EDO RAS# Precharge Time	: 4		
EDO DRAM Read Burst	: x333		
EDO DRAM Write Burst	: x333		
DRAM Data Integrity Mode	: Non-ECC		
CPU-To-PCI IDE Posting	: Enabled		
System BIOS Cacheable	: Enabled		
Video BIOS Cacheable	: Enabled		
Video RAM Cacheable	: Enabled		
8 Bit I/O Recovery Time	: 1		
16 Bit I/O Recovery Time	: 1		
Memory Hole At 15M-16M	: Disabled		
Passive Release	: Enabled	ESC : Quit	↑↓←→ : Select Item
Delayed Transaction	: Disabled	F1 : Help	PU/PD/+/- : Modify
SDRAM RAS-to-CAS Delay	: Slow	F5 : Old Values	(Shift)F2 : Color
SDRAM RAS Precharge Time	: Slow	F6 : Load BIOS Defaults	
SDRAM CAS latency Time	: 3	F7 : Load Setup Defaults	

Figure 3-3: CHIPSET features setup screen

Note: If you enable the IDE HDD block mode, the enhanced IDE driver will be enabled.

Power Management Setup

The power management setup controls the CPU card's "Green" features. The following screen shows the manufacturer's defaults.

ROM PCI/ISA BIOS (2A69JAK9)
 POWER MANAGEMENT SETUP
 AWARD SOFTWARE, INC.

Power Management	: Disable	** Reload Global Timer Events **	
PM Control by APM	: Yes	IRQ13-7,9-151,NMI	: Disabled
Video Off Method	: Blank Screen	Primary IDE 0	: Disabled
Video Off After	: Suspend	Primary IDE 1	: Disabled
MODEM Use IRQ	: 10	Secondary IDE 0	: Disabled
Doze Mode	: Disable	Secondary IDE 1	: Disabled
Standby Mode	: Disable	Floppy Disk	: Disabled
Suspend Mode	: Disable	Serial Port	: Disabled
HDD Power Down	: Disable	Parallel Port	: Disabled
Throttle Duty Cycle	: 12.5%		
ZZ Active in Suspend	: Enabled		
UGA Active Monitor	: Enabled		
Soft-Off by PWR-BTN	: Instant-Off		
Resume by Ring	: Enabled		
IRQ 8 Break Suspend	: Disabled		
		ESC : Quit	↑↓+* : Select Item
		F1 : Help	PU/PD/+/- : Modify
		F5 : Old Values	(Shift)F2 : Color
		F6 : Load BIOS Defaults	
		F7 : Load Setup Defaults	

Figure 3-4: Power management setup screen

Power Management

This option allows you to determine if the values in power management are disabled, user-defined, or predefined.

HDD Power Management

You can choose to turn the HDD off after one of the time intervals listed, or when the system is in Suspend mode. If the HDD is in a power saving mode, any access to it will wake it up.

Note: The HDD will not power down if the Power Management option is disabled.

IRQ Activity

IRQ can be set independently. Activity on any enabled IRQ will wake up the system.

PCI Configuration Setup

```
ROM PCI/ISA BIOS (2A69JAK9)
PNP/PCI CONFIGURATION
AWARD SOFTWARE, INC.

PNP OS Installed      : No
Resources Controlled By : Manual
Reset Configuration Data : Disabled

IRQ-3 assigned to : Legacy ISA
IRQ-4 assigned to : Legacy ISA
IRQ-5 assigned to : PCI/ISA PnP
IRQ-7 assigned to : PCI/ISA PnP
IRQ-9 assigned to : PCI/ISA PnP
IRQ-10 assigned to : PCI/ISA PnP
IRQ-11 assigned to : PCI/ISA PnP
IRQ-12 assigned to : PCI/ISA PnP
IRQ-14 assigned to : PCI/ISA PnP
IRQ-15 assigned to : PCI/ISA PnP
DMA-0 assigned to : PCI/ISA PnP
DMA-1 assigned to : PCI/ISA PnP
DMA-3 assigned to : PCI/ISA PnP
DMA-5 assigned to : PCI/ISA PnP
DMA-6 assigned to : PCI/ISA PnP
DMA-7 assigned to : PCI/ISA PnP

PCI IDE IRQ Map To : ISA

Used MEM base addr : N/A

ESC : Quit      | |← : Select
F1  : Help      | PU/PD/+/- : Mo
F5  : Old Values (Shift)F2 : Co
F6  : Load BIOS Defaults
F7  : Load Setup Defaults
```

Figure 3-5: PCI configuration screen

Load BIOS Defaults

“LOAD BIOS DEFAULTS” indicates the most appropriate values for the system parameters for minimum performance. These default values are loaded automatically if the stored record created by the setup program becomes corrupted (and therefore unusable).

Load Setup Defaults

“LOAD SETUP DEFAULTS” loads the values required by the system for maximum performance.

Integrated Peripherals

ROM PCI/ISA BIOS (2A69JAK9)
 INTEGRATED PERIPHERALS
 AWARD SOFTWARE, INC.

IDE HDD Block Mode	: Enabled	Onboard Parallel Port	: 378/IRQ7
IDE Primary Master PIO	: Auto	Parallel Port Mode	: ECP+EPP
IDE Primary Slave PIO	: Auto	ECP Mode Use DMA	: 3
IDE Secondary Master PIO	: Auto	EPP Mode Select	: EPP1.9
IDE Secondary Slave PIO	: Auto		
IDE Primary Master UDMA	: Auto		
IDE Primary Slave UDMA	: Auto		
IDE Secondary Master UDMA	: Auto		
IDE Secondary Slave UDMA	: Auto		
On-Chip Primary PCI IDE	: Enabled		
On-Chip Secondary PCI IDE	: Enabled		
USB Keyboard Support	: Disabled		
RBC input clock	: 8 MHz		
Onboard FDC Controller	: Enabled	ESC : Quit	↑↓←→ : Select Item
Onboard Serial Port 1	: 3F8/IRQ4	F1 : Help	PU/PD/+/- : Modify
Onboard Serial Port 2	: 2F8/IRQ3	F5 : Old Values (Shift)	F2 : Color
UART Mode Select	: Normal	F6 : Load BIOS Defaults	
		F7 : Load Setup Defaults	

Figure 3-6: Integrated peripherals

Password Setting

To change the password:

1. Choose the "PASSWORD SETTING" option from the Setup main menu and press <Enter>.

The screen will display the following message:



```
Enter Password:
```

Press <Enter>.

2. If the CMOS is good or if this option has been used to change the default password, the user is asked for the password stored in the CMOS. The screen will display the following message:

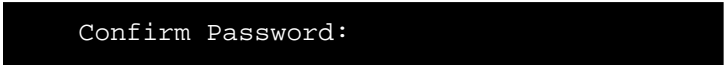

```
Confirm Password:
```

Enter the current password and press <Enter>.

3. After pressing <Enter> (ROM password) or the current password (user-defined), you can change the password stored in the CMOS. The password must be no longer than eight (8) characters.

Remember, to enable the password setting feature, you must first select either Setup or System to secure your option in "BIOS FEATURES SETUP".

IDE HDD Auto Detection

"IDE HDD AUTO DETECTION" automatically self-detects for the correct hard disk type.

Save & Exit Setup

If you select this and press <Enter>, the values entered in the setup utilities will be recorded in the CMOS memory of the chipset. The microprocessor will check this every time you turn your system on and compare this to what it finds as it checks the system. This record is required for the system to operate.

Exit Without Saving

Selecting this option and pressing <Enter> lets you exit the setup program without recording any new values or changing old ones.

CHAPTER 4

On-board Security Setup

This chapter explains OBS concepts and provides instructions for installing the relevant software drivers. This is done using the OBS driver disks included in your SBC-775 package.

Introduction

On-board security (OBS) functions monitor key hardware. They help you maintain your system's stability and durability.

The SBC-775 can monitor 5 sets of system positive voltages, 2 sets of system negative voltages, CPU cooling fan speed, and CPU temperature.

The positive system voltage sets which can be monitored include:

- CPU core voltage: 1.7 V ~ 3.3 V, according to Intel specifications
- Transmission voltage from CPU to chipset: typically 1.5 V
- Chipset voltage: typically 3.3 V
- Main voltage: +5 V, +12 V

The negative system voltage sets which can be monitored include:

- Main voltage: -5 V, -12 V

Installation of OBS devices

After you have mounted the CPU and cooling modules, enable the OBS functions as follows:

1. Take the specially designed temperature sensor cable out of the accessories bag.
2. Connect the 2-pin header of the cable to connector RT1.
3. Attach the sticker to the heat sink, but NOT on the plastic portion of the heat sink.
4. Place the sensor on the nearest part of the CPU, to ensure that true CPU temperature is measured.

Driver installation

Necessary prerequisites

The instructions in this manual assume that you understand elementary concepts of MS-DOS and the IBM personal computer. Before you attempt to install any driver or utility, you should know how to copy files from a floppy disk to a directory on the hard disk; understand the MS-DOS directory structure; and know how to format a floppy disk. If you are uncertain about any of these concepts, please refer to DOS or Windows user reference guides for more information before you proceed with the installation.

Before you begin

Before you begin installing software drivers, you should make a backup copy of the display driver disk and store the original in a safe place. The display driver disk contains drivers for several versions of certain applications. You must install the correct version in order for the driver to work properly, so make sure you know which version of the application you have.

Utility disk 1: OBS Monitor Win95 V 1.00 #1

Utility disk 2: OBS Monitor Win95 V 1.00 #2

Windows 95 drivers setup procedure

1. Insert the OBS driver disk into drive A:.

Type:

A:\setup.exe

Press <Enter> to run the driver SETUP program.



Figure 4-1: Hardware Doctor setup - initial screen

2. If your operating system is Win95, you will see the following screen images after running the driver. You must then reboot your system, start the procedure from Step 1 again, and then proceed directly to Step 3.



Figure 4-2: Setup under Win95



Figure 4-3: Restarting Windows

3. Follow the screen instructions to install the software.



Figure 4-4: Hardware Doctor setup - installation screen

4. Complete the setup.

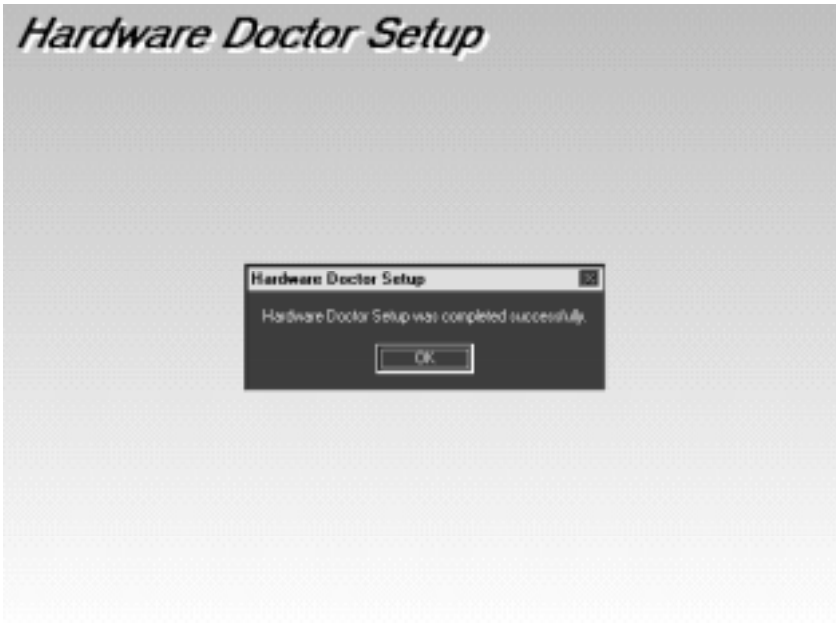

Figure 4-5: Hardware Doctor setup - completion screen

5. Using your file manager, click on "Hardware Doctor" in drive C:, and then click on "W83781".

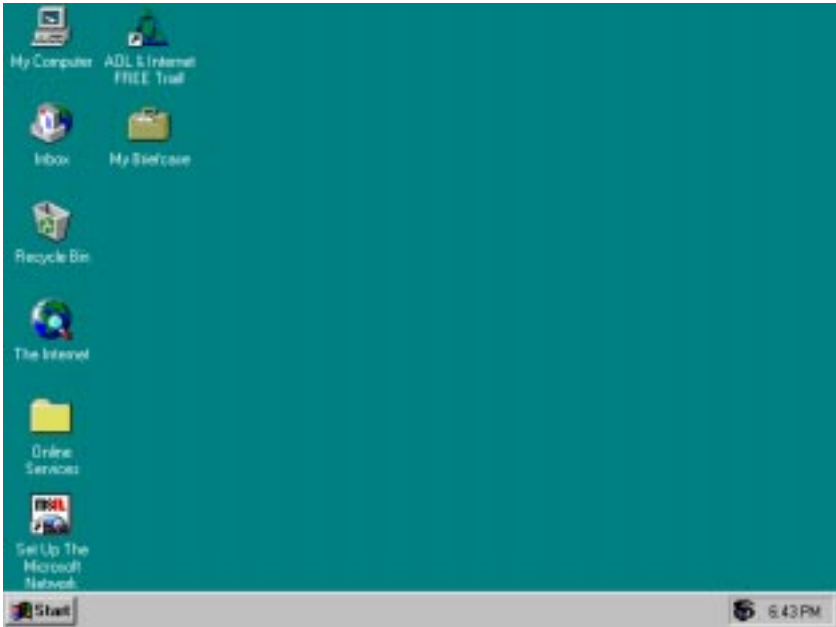

Figure 4-6: Exploring - Hardware Doctor

- It is recommended that you load the default values for all the OBS settings. However, if desired, you can establish new conditions for voltage, fan speed and temperature.

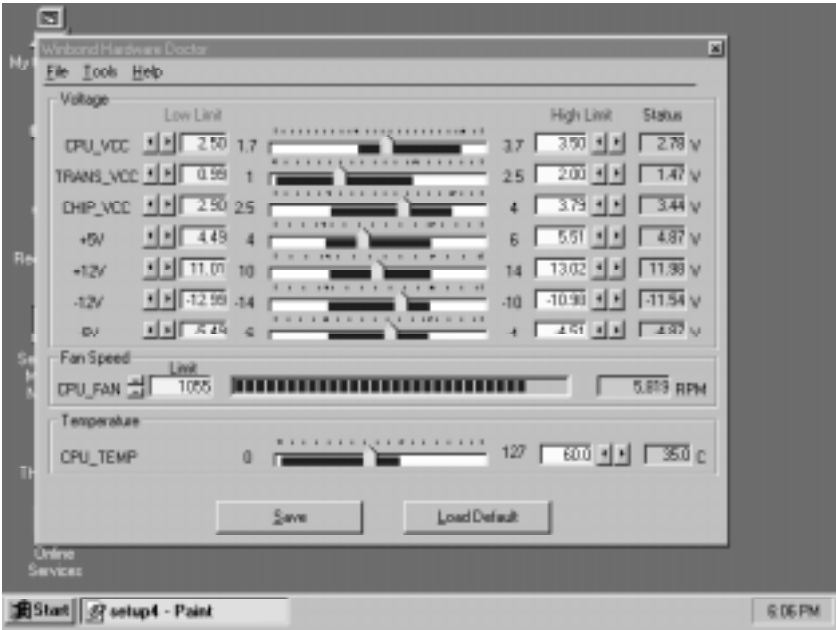

Figure 4-7: Winbond Hardware Doctor

7. "Winbond Hardware Doctor" will show an icon on the right side of the bottom window bar. This icon is the "Terminate and Stay Resident" (TSR) icon. It will permanently remain in the bottom window bar, and will activate warning signals when triggered by the on-board security system.

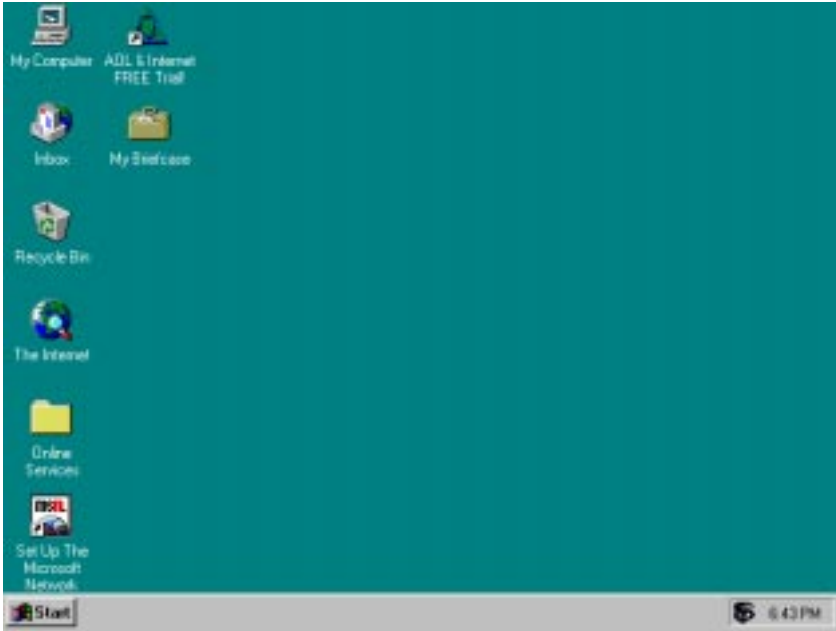

Figure 4-8: "Terminate and Stay Resident" (TSR) icon on the right side of the bottom window bar

- Click on "Tools", then "Monitoring Config." While enabling each OBS function, you can choose "Faults 1". This will result in a warning message being delivered as soon as any monitored reading exceeds safe limits for the first time. Alternatively, you can set up "Count 3". This will result in a warning message being delivered only after any monitored reading exceeds safe limits for a third time. It is recommended that you load the default settings for all the OBS functions.



Figure 4-9: Monitoring Config.

9. After completing the setup, all the OBS functions are permanently enabled. When a monitored reading exceeds safe limits, a warning message will be displayed and an error beep tone will activate to attract your attention.



Figure 4-10: Warning display

Programming the Watchdog Timer

The SBC-775 is equipped with a watchdog timer that resets the CPU or generates an interrupt if processing comes to a stand-still for any reason. This feature ensures system reliability in industrial standalone or unmanned environments.

Programming the watchdog timer

The watchdog timer uses 32.768 MHz frequency source to counter a 24-bit Counter, so the timer range is from 30.5u sec to 512 sec with resolution 30.5u sec. When timer times out, a system reset, NMI or IRQ may happen to be decided by user's programming.

Configuration register

The watchdog timer of SBC-357 is located on the chipset - ALI M6117C. If you want to use it, you have to know how to read/write the configuration register of M6117C. Following is the basic procedure.

1. Open the chip.
2. Write/Read data to/from register.
3. Close the chip.

To Open/Close the chip is to write a specific value to register 13h.

Index 13h:

c5h: open the chip

00h: close the chip

Here we give you an example of writing data to register.

```
mov    al, 13h
Out    22h, al
jmp    $+2    ;;delay
jmp    $+2    ;;delay
mov    al, 0c5h
out    23h, al
```

* **note:** 22h is the index I/O port, 23h is the data I/O port.

How to set the watchdog timer

1. Set index 37h bit 6 = 0 to disable the timer.
2. Write the desired counter value to 3Bh, 3Ah, 39h.
3. Set index 37h bit 6 = 1 to enable the timer.
4. When counter reaches the setting value, the timer will generate signal setting by index 38h bit [7:4]

Example

Following is an example of programming 1 sec period for watchdog timer in assembly language. When timer times out, it will generate system reset.

Pin Assignments

This appendix contains information of a detailed or specialized nature. It includes:

- RS-232 serial port connector
- Keyboard and mouse connector
- External keyboard connector
- ATX feature connector
- IDE hard drive connector
- USB connector
- CPU fan power connector
- Floppy drive connector
- Parallel port connector
- IR connector
- HDD LED connector
- Power LED and keylock connector
- External speaker
- System I/O ports
- DMA channel assignments
- Interrupt assignments
- 1st MB memory map

COM1/COM2 RS-232 Serial Port (CN9,CN10)

Table B-1: COM1/COM2 RS-232 serial port (CN9)

Pin	Signal
1	DCD
2	RXD
3	TXD
4	DTR
5	GND
6	DSR
7	RTS
8	CTS
9	RI

Keyboard and Mouse Connector (CN12)

Table B-2: Keyboard and mouse connector (CN12)

Pin	Signal
1	KB DATA
2	MS DATA
3	GND
4	V_{cc}
5	KB CLOCK
6	MS CLOCK

External Keyboard Connector (J10)

Table B-3: External keyboard connector (J10)

Pin	Signal
1	CLK
2	DATA
3	NC
4	GND
5	V_{cc}

ATX Feature Connector (J7)

Table B-4: ATX feature connector (J7)

Pin	Signal
1	5VSB
2	NC
3	PS-ON

IDE Hard Drive Connector (CN6, CN7)

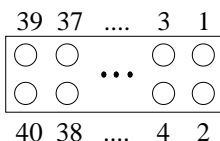

Table B-5: IDE hard drive connector (CN6, CN7)

Pin	Signal	Pin	Signal
1	IDE RESET*	2	GND
3	DATA 7	4	DATA 8
5	DATA 6	6	DATA 9
7	DATA 5	8	DATA 10
9	DATA 4	10	DATA 11
11	DATA 3	12	DATA 12
13	DATA 2	14	DATA 13
15	DATA 1	16	DATA 14
17	DATA 0	18	DATA 15
19	SIGNAL GND	20	N/C
21	N/C	22	GND
23	IO WRITE	24	GND
25	IO READ	26	GND
27	IO CHANNEL READY	28	N/C
29	HDACKO*	30	GND
31	IRQ14	32	IOCS16
33	ADDR 1	34	N/C
35	ADDR 0	36	ADDR 2
37	HARD DISK SELECT 0*	38	HARD DISK SELECT 1*
39	IDE ACTIVE*	40	GND

* Low active

USB Connector (CN11)

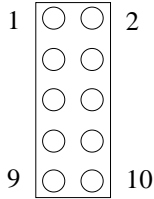

Table B-6: USB1/USB2 connector (CN11)

Pin	USB1 Signal	Pin	USB2 Signal
1	+5 V	2	+5 V
3	UV-	4	UV-
5	UV+	6	UV+
7	GND	8	GND
9	Chassis GND	10	N/C

CPU Fan Power Connector (CN5)

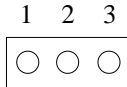

Table B-7: CPU fan power connector (CN5)

Pin	Signal
1	Detect
2	+12 V
3	GND

Floppy Drive Connector (CN13)

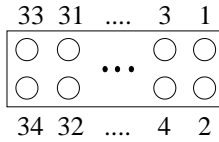

Table B-8: Floppy drive connector (CN13)

Pin	Signal	Pin	Signal
1	GND	2	DENSITY SELECT*
3	GND	4	N/C
5	GND	6	N/C
7	GND	8	INDEX*
9	GND	10	MOTOR 0*
11	GND	12	DRIVE SELECT 1*
13	GND	14	DRIVE SELECT 0*
15	GND	16	MOTOR 1*
17	GND	18	DIRECTION*
19	GND	20	STEP*
21	GND	22	WRITE DATA*
23	GND	24	WRITE GATE*
25	GND	26	TRACK 0*
27	GND	28	WRITE PROTECT*
29	GND	30	READ DATA*
31	GND	32	HEAD SELECT*
33	GND	34	DISK CHANGE*

* Low active

Parallel Port Connector (CN8)

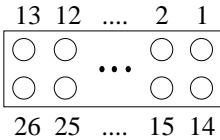

Table B-9: Parallel port connector (CN8)

Pin	Signal
1	\STROBE
2	\AUTOFD
3	D0
4	ERR
5	D1
6	\INIT
7	D2
8	\SLCTINI
9	D3
10	GND
11	D4
12	GND
13	D5
14	GND
15	D6
16	GND
17	D7
18	GND
19	\ACK
20	GND
21	BUSY
22	GND
23	PE
24	GND
25	SLCT
26	N/C

IR Connector (CN1)

Table B-10: IR connector (CN1)

Pin	Signal
1	+5 V
2	N/C
3	IR_RX
4	GND
5	IR_TX

HDD LED Connector (CN4)

Table B-11: HDD LED connector

Pin	Signal
1	V _{cc}
2	LED

Power LED and Keylock Connector (CN2)

You can use an LED to indicate when the CPU card is on. Pin 1 of CN2 supplies the LED's power, and Pin 3 is the ground.

You can use a switch (or a lock) to disable the keyboard so that the PC will not respond to any input. This is useful if you do not want anyone to change or stop a program which is running. Simply connect the switch from Pin 4 to Pin 5 of CN2.

Table B-12: Power LED and keylock connector (CN2)

Pin	Function
1	LED power (+5 V)
2	NC
3	GND
4	Keyboard lock
5	GND

External Speaker (CN3)

The CPU card has its own buzzer. You can also connect it to the external speaker on your computer chassis.

Table B-13: External speaker (CN3)

Pin	Function
1	+5 V _{CC}
2	GND
3	Internal buzzer
4	Speaker out

System I/O Ports

Table B-14: System I/O ports

Addr. range (Hex)	Device
000-01F	DMA controller
020-021	Interrupt controller 1, master
022-023	Chipset address
040-05F	8254 timer
060-06F	8042 (keyboard controller)
070-07F	Real-time clock, non-maskable interrupt (NMI) mask
080-09F	DMA page register,
0A0-0BF	Interrupt controller 2
0C0-0DF	DMA controller
0F0	Clear math co-processor
0F1	Reset math co-processor
0F8-0FF	Math co-processor
1F0-1F8	Fixed disk
200-207	Game I/O
278-27F	Parallel printer port 2 (LPT 3)
2F8-2FF	Serial port 2
300-31F	Prototype card
360-36F	Reserved
378-37F	Parallel printer port 1 (LPT 2)
380-38F	SDLC, bisynchronous 2
3A0-3AF	Bisynchronous 1
3B0-3BF	Monochrome display and printer adapter (LPT1)
3C0-3CF	Reserved
3D0-3DF	Color/graphics monitor adapter
3F0-3F7	Diskette controller
3F8-3FF	Serial port 1

DMA Channel Assignments

Table B-15: DMA channel assignments

Channel	Function
0	Available
1	Available
2	Floppy disk (8-bit transfer)
3	Available
4	Cascade for DMA controller 1
5	Available
6	Available
7	Available

Interrupt Assignments

Table B-16: Interrupt assignments

Priority	Interrupt#	Interrupt source
1	NMI	Parity error detected
2	IRQ 0	Interval timer
3	IRQ 1	Keyboard
-	IRQ 2	Interrupt from controller 2 (cascade)
4	IRQ 8	Real-time clock
5	IRQ 9	Cascaded to INT 0A (IRQ 2)
6	IRQ 10	Available
7	IRQ 11	Available
8	IRQ 12	PS/2 mouse
9	IRQ 13	INT from co-processor
10	IRQ 14	Fixed disk controller
11	IRQ 15	Available
12	IRQ 3	Serial communication port 2
13	IRQ 4	Serial communication port 1
14	IRQ 5	Parallel port 2
15	IRQ 6	Diskette controller (FDC)
16	IRQ 7	Parallel port 1 (print port)

1st MB Memory Map

Table B-17: 1st MB memory map

Addr. range (Hex)	Device
F000h - FFFFh	System ROM
C800h - EFFFh	Unused
C000h - C7FFh	VGA BIOS
B800h - BFFFh	CGA/EGA/VGA text
B000h - B7FFh	Unused
A000h - AFFFh	EGA/VGA graphics
0000h - 9FFFh	Base memory

APPENDIX

C

DOC[®] 2000 Installation Guide

This appendix contains information on the DiskOnChip[®] 2000 quick installation guide. It includes:

- DiskOnChip 2000 installation instructions
- Additional information and assistance

DiskOnChip® 2000 Quick Installation Guide

DiskOnChip 2000 installation instructions

1. Make sure the target platform is powered OFF.
2. Plug the DiskOnChip® 2000 device into its socket. Verify the direction is correct (pin 1 of the DiskOnChip® 2000 is aligned with pin 1 of the socket).
3. Power up the system.
4. During power up you may observe the messages displayed by the DiskOnChip® 2000 when its drivers are automatically loaded into the system's memory.
5. At this stage the DiskOnChip® 2000 can be accessed as any disk in the system.
6. If the DiskOnChip® 2000 is the only disk in the system, it will appear as the first disk (drive C: in DOS).
7. If there are more disks besides the DiskOnChip 2000, the DiskOnChip® 2000 will appear by default as the last drive, unless it was programmed as the first drive. (Please refer to the DiskOnChip® 2000 utilities user manual.)
8. If you want the DiskOnChip® 2000 to be bootable:
 - a . Copy the operating system files into the DiskOnChip® by using the standard DOS command (for example: sys d:).
 - b . The DiskOnChip® should be the only disk in the systems or would be configured as the first disk in the system (c:) using the DUPDATE utility.

```
DUPDATE D /S: DOC104.EXB /FIRST (set as c:)
DUPDATE C /S: DOC104.EXB (set as d:)
```

Additional information and assistance

1. Visit M-Systems' Web site at www.m-sys.com where you can find Utilities, Manual, Data Sheet, and Application Notes. In addition, you can find the latest DiskOnChip® 2000 S/W Utilities.
2. Contact your dealer for technical support if you need additional assistance, and have the following information ready:
 - Product name and serial number.
 - Description of your computer hardware (manufacturer, model, attached devices, etc.)
 - Description of your software (operating system, version, application software, etc.)
 - A complete description of the problem.
 - The exact wording of any error messages.

